

# FASTTRAK

## Simple, Strong, Quick & Easy.

### F62-D

### ASSEMBLY INSTRUCTIONS

REVISION 02/19



How to build Video



W2105mm x D720mm x H1800mm

### NOTES

BEFORE COMMENCING SHED ASSEMBLY, CHECK ALL PARTS.

DO NOT ASSEMBLE IN WINDY CONDITIONS



READ INSTRUCTIONS FIRST



2 PERSON ASSEMBLY



THE MANUFACTURERS CANNOT BE HELD RESPONSIBLE FOR ANY CONSEQUENCES DUE TO SHEDS THAT ARE NOT INSTALLED PER INSTRUCTIONS OR FOR DAMAGE DUE TO WEATHER CONDITIONS, ACTS OF GOD OR FOR SHEDS THAT ARE LEFT PARTIALLY ASSEMBLED OVERNIGHT. PARTS MAY CONTAIN SHARP EDGES & CORNERS. CARE MUST BE TAKEN WHEN HANDLING VARIOUS PIECES TO AVOID A MISHAP, FOR SAFETY SAKE, PLEASE USE A PAIR OF WORK GLOVES, EYE PROTECTION & PROTECTIVE CLOTHING WHEN ASSEMBLING OR PERFORMING ANY MAINTENANCE ON THE BUILDING.

Subject to changes © STEEL SHEDS AUSTRALIA PTY LIMITED

## TOOLS REQUIRED

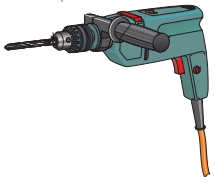

Electric Drill



Cordless Drill



Measuring Tape



Screwdrivers



8mm Masonry Drill Bit

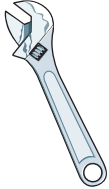

Shifting Spanner



Builders Pencil



5mm Drill bit



Rubber Mallet



Sturdy Ladder  
(two if possible)

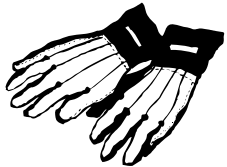

Gloves



Protective Eyewear

## HANDY HINTS FOR CONSTRUCTION

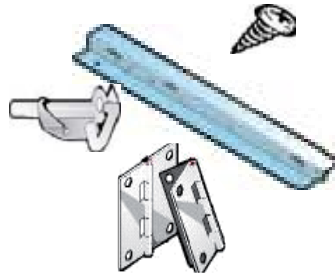

Read instructions and check parts carefully before assembling the shed.

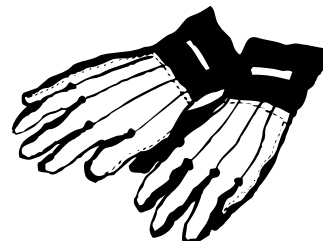

Please wear safety gloves and glasses at all times to protect against sharp metal edges.

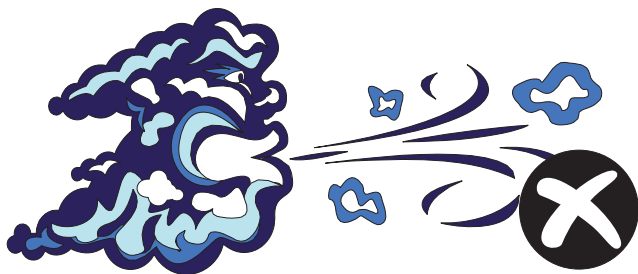

Do not assemble in windy conditions as panels may be difficult to handle and damage may result.

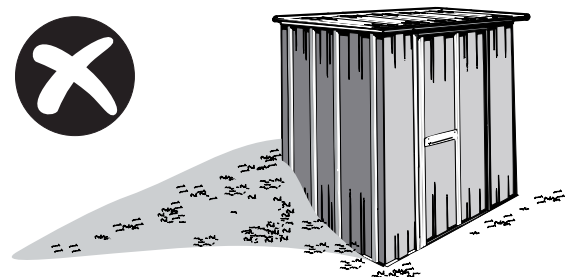



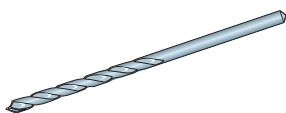





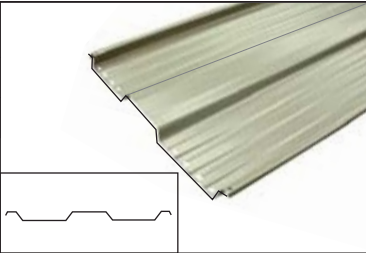
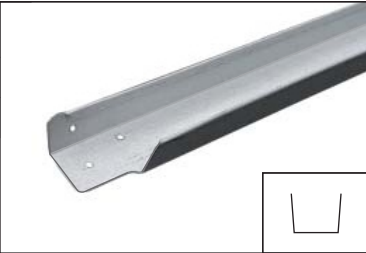
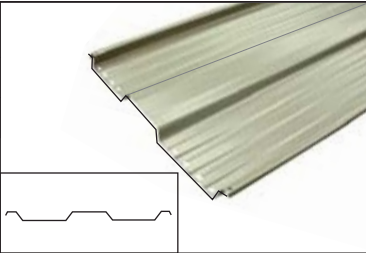
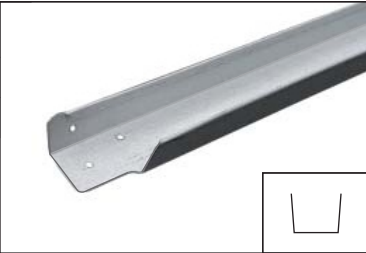
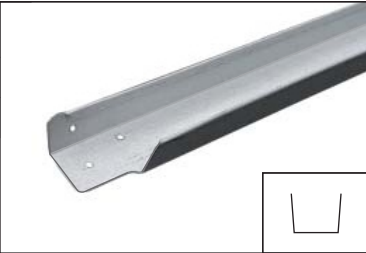
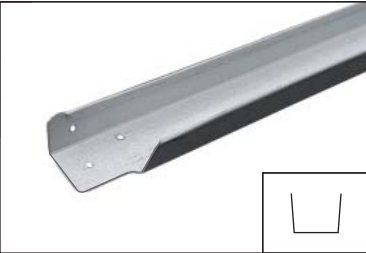
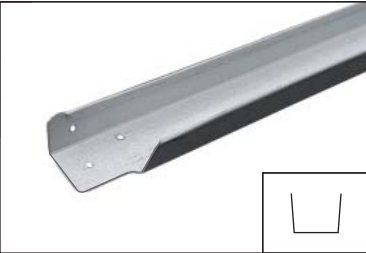
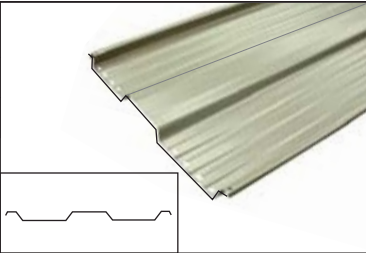
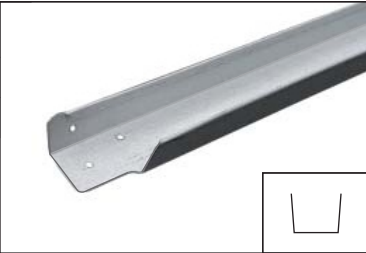
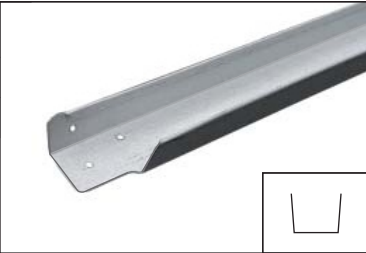
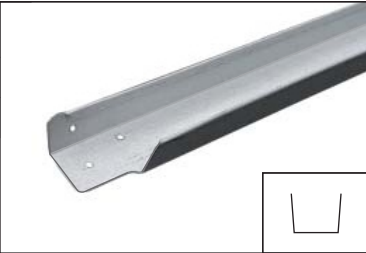
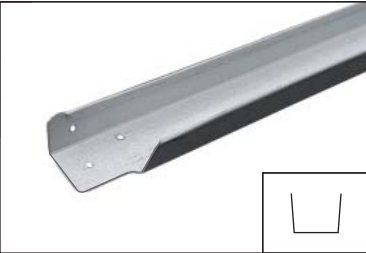
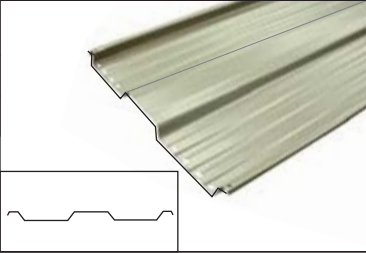
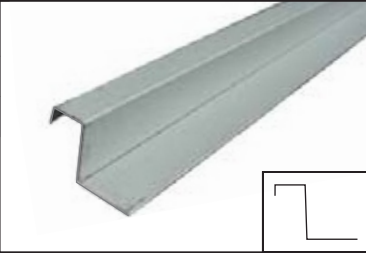
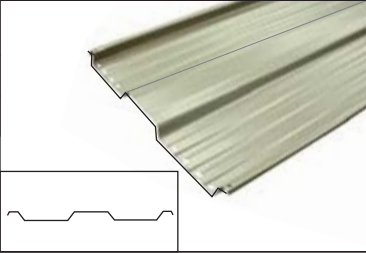
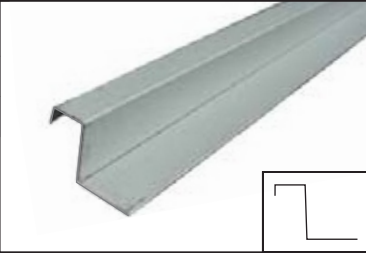
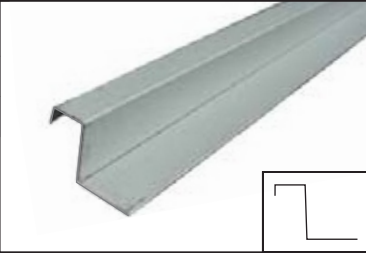
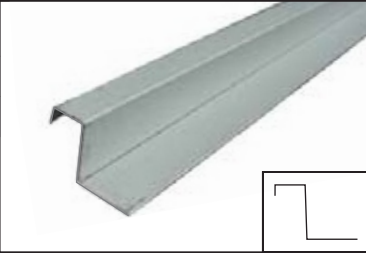
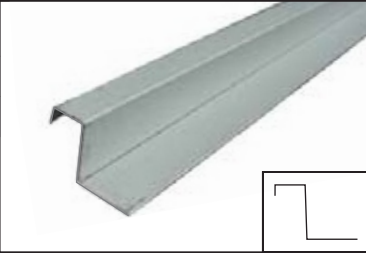
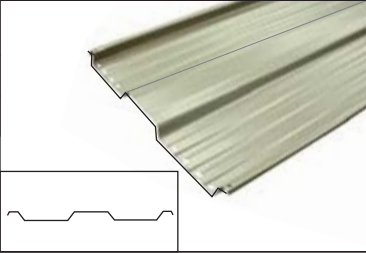
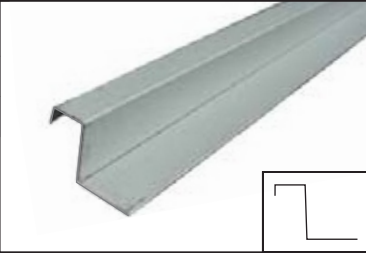
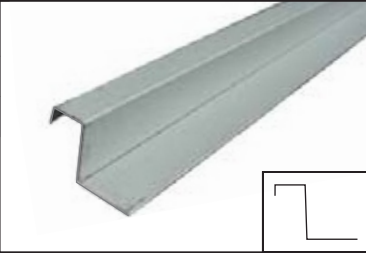
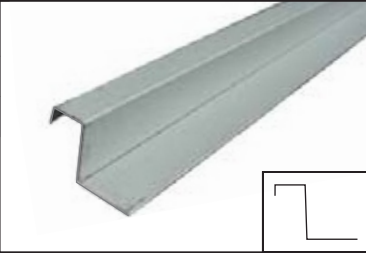
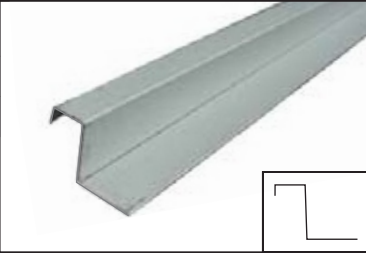

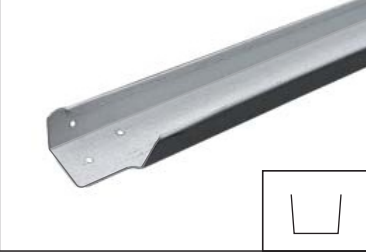

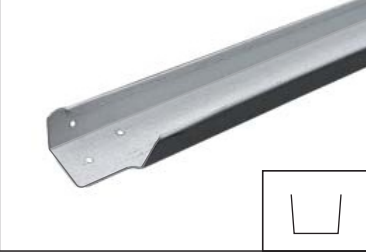
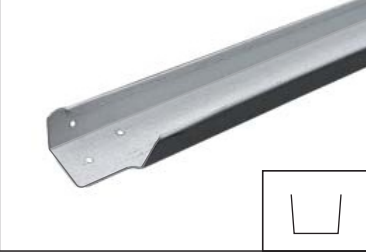
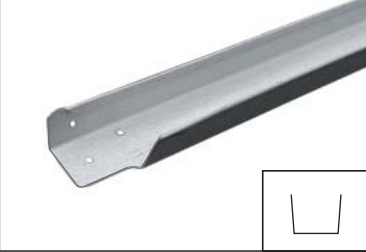
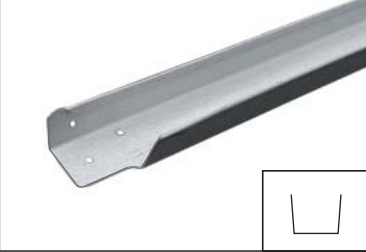

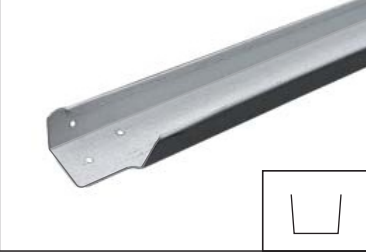
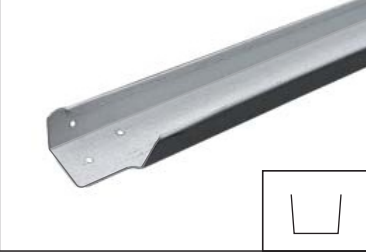
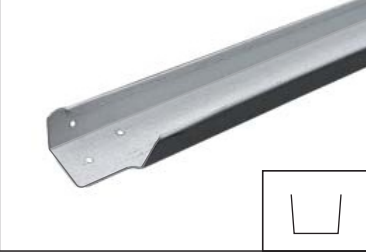
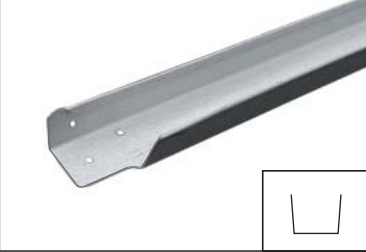
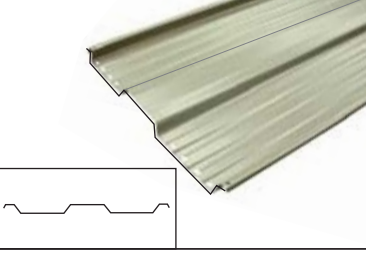
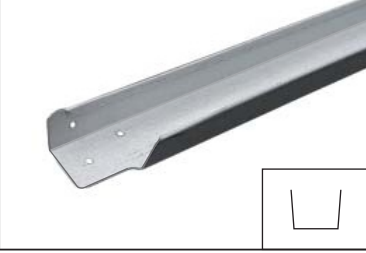
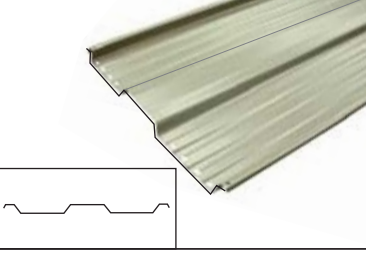
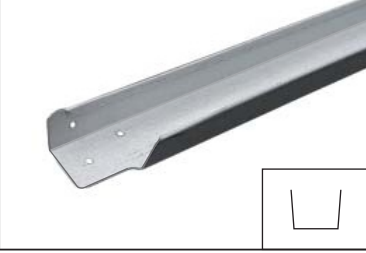
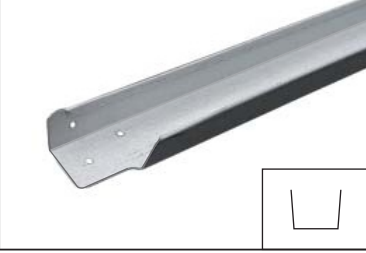
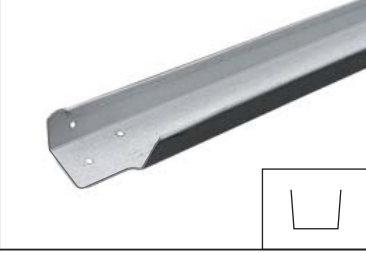
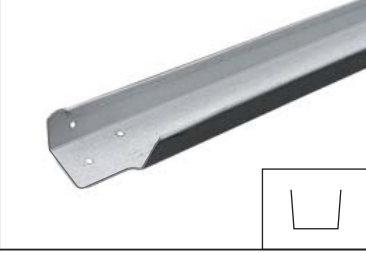
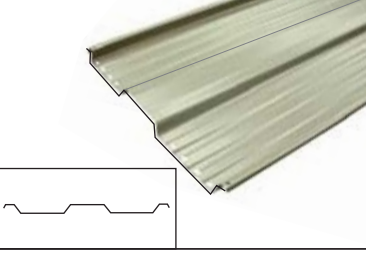
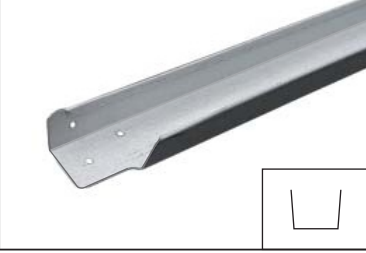
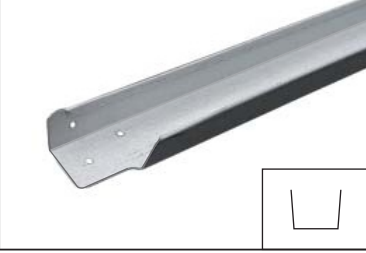
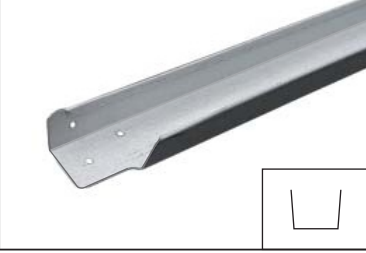
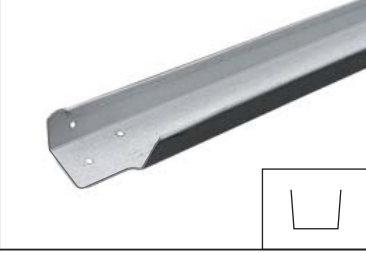
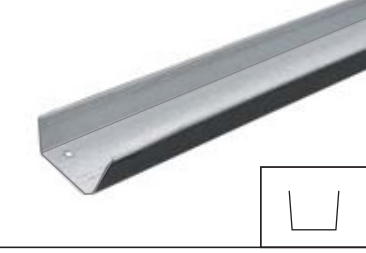
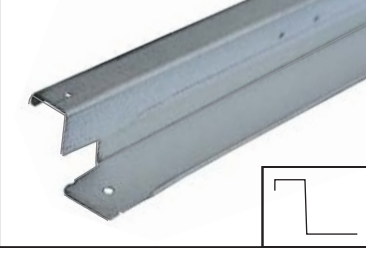
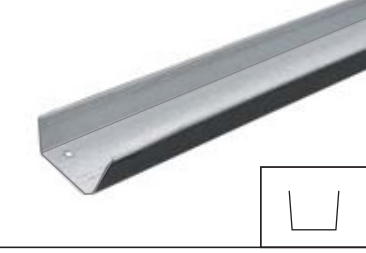
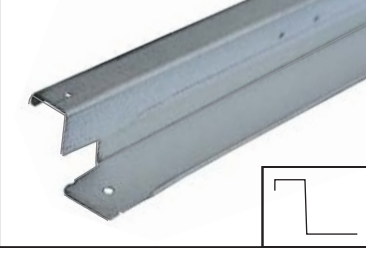
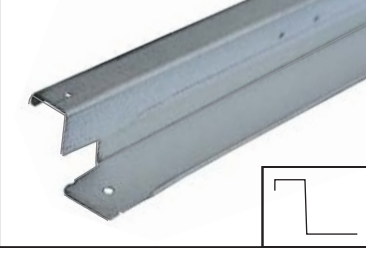
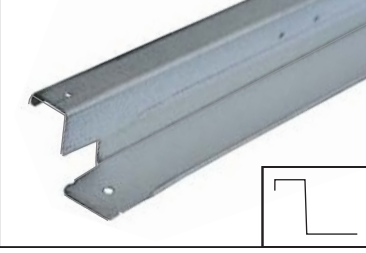
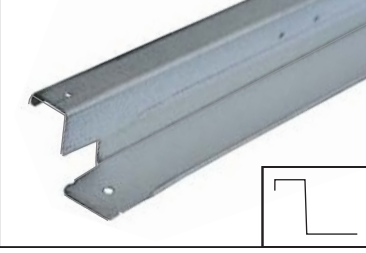
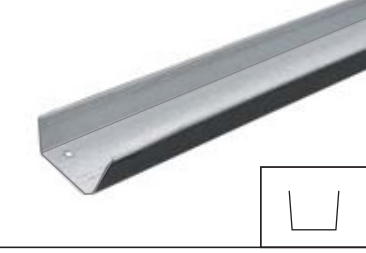
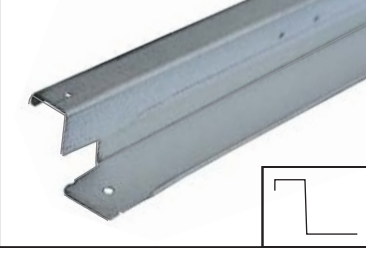
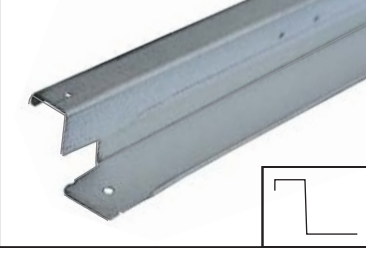
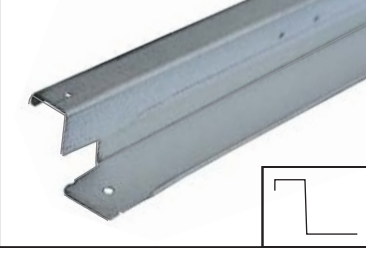
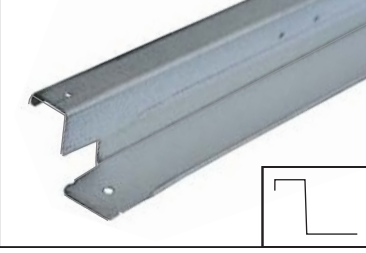
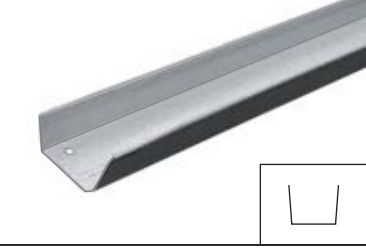

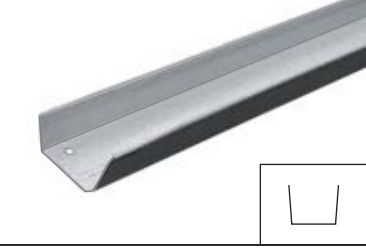



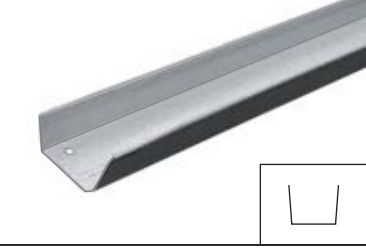







Do not back fill against the shed as this will result in corrosion. Allow drainage from the site.











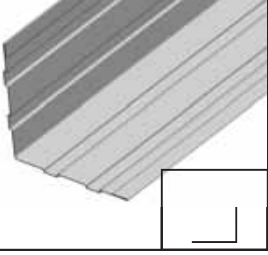

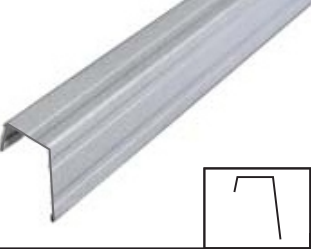

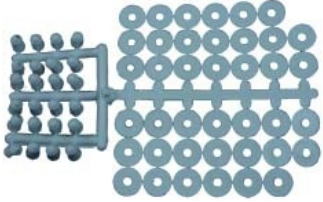
**MOST PILOT HOLES ARE PRE-PUNCHED AND IN THIS CASE DRILLING HOLES IS NOT NECESSARY, HOWEVER SOME PILOT HOLES NEED TO BE DRILLED WITH THE INCLUDED 2.5MM DRILL BIT WHERE INDICATED**

# PARTS LIST

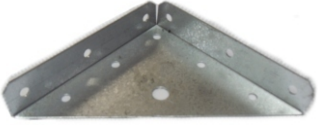
<table border="1"> <tr> <td><b>PRODUCT ID</b></td> <td><b>C</b></td> <td rowspan="4">  </td> <td> <table border="1"> <tr> <td><b>PRODUCT ID</b></td> <td><b>K</b></td> <td rowspan="4">  </td> </tr> <tr> <td><b>Length</b></td> <td>1800mm</td> </tr> <tr> <td><b>Quantity</b></td> <td>8</td> </tr> <tr> <td colspan="2"><b>Description:</b> Wall Panel</td> </tr> </table> </td> </tr> <tr> <td><b>Length</b></td> <td>1800mm</td> </tr> <tr> <td><b>Quantity</b></td> <td>8</td> </tr> <tr> <td colspan="2"><b>Description:</b> Wall Panel</td> </tr> </table>	<b>PRODUCT ID</b>	<b>C</b>		<table border="1"> <tr> <td><b>PRODUCT ID</b></td> <td><b>K</b></td> <td rowspan="4">  </td> </tr> <tr> <td><b>Length</b></td> <td>1800mm</td> </tr> <tr> <td><b>Quantity</b></td> <td>8</td> </tr> <tr> <td colspan="2"><b>Description:</b> Wall Panel</td> </tr> </table>	<b>PRODUCT ID</b>	<b>K</b>		<b>Length</b>	1800mm	<b>Quantity</b>	8	<b>Description:</b> Wall Panel		<b>Length</b>	1800mm	<b>Quantity</b>	8	<b>Description:</b> Wall Panel		<table border="1"> <tr> <td><b>PRODUCT ID</b></td> <td><b>K</b></td> <td rowspan="4">  </td> </tr> <tr> <td><b>Length</b></td> <td>1040mm</td> </tr> <tr> <td><b>Quantity</b></td> <td>4</td> </tr> <tr> <td colspan="2"><b>Description:</b> Door Bracing</td> </tr> </table>	<b>PRODUCT ID</b>	<b>K</b>		<b>Length</b>	1040mm	<b>Quantity</b>	4	<b>Description:</b> Door Bracing	
<b>PRODUCT ID</b>	<b>C</b>			<table border="1"> <tr> <td><b>PRODUCT ID</b></td> <td><b>K</b></td> <td rowspan="4">  </td> </tr> <tr> <td><b>Length</b></td> <td>1800mm</td> </tr> <tr> <td><b>Quantity</b></td> <td>8</td> </tr> <tr> <td colspan="2"><b>Description:</b> Wall Panel</td> </tr> </table>	<b>PRODUCT ID</b>	<b>K</b>			<b>Length</b>	1800mm	<b>Quantity</b>	8	<b>Description:</b> Wall Panel																
<b>PRODUCT ID</b>	<b>K</b>																												
<b>Length</b>	1800mm																												
<b>Quantity</b>	8																												
<b>Description:</b> Wall Panel																													
<b>Length</b>	1800mm																												
<b>Quantity</b>	8																												
<b>Description:</b> Wall Panel																													
<b>PRODUCT ID</b>	<b>K</b>																												
<b>Length</b>	1040mm																												
<b>Quantity</b>	4																												
<b>Description:</b> Door Bracing																													
<table border="1"> <tr> <td><b>PRODUCT ID</b></td> <td><b>D</b></td> <td rowspan="4">  </td> <td> <table border="1"> <tr> <td><b>PRODUCT ID</b></td> <td><b>L</b></td> <td rowspan="4">  </td> </tr> <tr> <td><b>Length</b></td> <td>1800mm</td> </tr> <tr> <td><b>Quantity</b></td> <td>4</td> </tr> <tr> <td colspan="2"><b>Description:</b> Wall Corner Panel</td> </tr> </table> </td> </tr> <tr> <td><b>Length</b></td> <td>1800mm</td> </tr> <tr> <td><b>Quantity</b></td> <td>4</td> </tr> <tr> <td colspan="2"><b>Description:</b> Wall Corner Panel</td> </tr> </table>	<b>PRODUCT ID</b>	<b>D</b>		<table border="1"> <tr> <td><b>PRODUCT ID</b></td> <td><b>L</b></td> <td rowspan="4">  </td> </tr> <tr> <td><b>Length</b></td> <td>1800mm</td> </tr> <tr> <td><b>Quantity</b></td> <td>4</td> </tr> <tr> <td colspan="2"><b>Description:</b> Wall Corner Panel</td> </tr> </table>	<b>PRODUCT ID</b>	<b>L</b>		<b>Length</b>	1800mm	<b>Quantity</b>	4	<b>Description:</b> Wall Corner Panel		<b>Length</b>	1800mm	<b>Quantity</b>	4	<b>Description:</b> Wall Corner Panel		<table border="1"> <tr> <td><b>PRODUCT ID</b></td> <td><b>L</b></td> <td rowspan="4">  </td> </tr> <tr> <td><b>Length</b></td> <td>1706mm</td> </tr> <tr> <td><b>Quantity</b></td> <td>1</td> </tr> <tr> <td colspan="2"><b>Description:</b> Door Seal</td> </tr> </table>	<b>PRODUCT ID</b>	<b>L</b>		<b>Length</b>	1706mm	<b>Quantity</b>	1	<b>Description:</b> Door Seal	
<b>PRODUCT ID</b>	<b>D</b>			<table border="1"> <tr> <td><b>PRODUCT ID</b></td> <td><b>L</b></td> <td rowspan="4">  </td> </tr> <tr> <td><b>Length</b></td> <td>1800mm</td> </tr> <tr> <td><b>Quantity</b></td> <td>4</td> </tr> <tr> <td colspan="2"><b>Description:</b> Wall Corner Panel</td> </tr> </table>	<b>PRODUCT ID</b>	<b>L</b>			<b>Length</b>	1800mm	<b>Quantity</b>	4	<b>Description:</b> Wall Corner Panel																
<b>PRODUCT ID</b>	<b>L</b>																												
<b>Length</b>	1800mm																												
<b>Quantity</b>	4																												
<b>Description:</b> Wall Corner Panel																													
<b>Length</b>	1800mm																												
<b>Quantity</b>	4																												
<b>Description:</b> Wall Corner Panel																													
<b>PRODUCT ID</b>	<b>L</b>																												
<b>Length</b>	1706mm																												
<b>Quantity</b>	1																												
<b>Description:</b> Door Seal																													
<table border="1"> <tr> <td><b>PRODUCT ID</b></td> <td><b>E</b></td> <td rowspan="4">  </td> <td> <table border="1"> <tr> <td><b>PRODUCT ID</b></td> <td><b>M</b></td> <td rowspan="4">  </td> </tr> <tr> <td><b>Length</b></td> <td>803mm</td> </tr> <tr> <td><b>Quantity</b></td> <td>6</td> </tr> <tr> <td colspan="2"><b>Description:</b> Roof Panel</td> </tr> </table> </td> </tr> <tr> <td><b>Length</b></td> <td>803mm</td> </tr> <tr> <td><b>Quantity</b></td> <td>6</td> </tr> <tr> <td colspan="2"><b>Description:</b> Roof Panel</td> </tr> </table>	<b>PRODUCT ID</b>	<b>E</b>		<table border="1"> <tr> <td><b>PRODUCT ID</b></td> <td><b>M</b></td> <td rowspan="4">  </td> </tr> <tr> <td><b>Length</b></td> <td>803mm</td> </tr> <tr> <td><b>Quantity</b></td> <td>6</td> </tr> <tr> <td colspan="2"><b>Description:</b> Roof Panel</td> </tr> </table>	<b>PRODUCT ID</b>	<b>M</b>		<b>Length</b>	803mm	<b>Quantity</b>	6	<b>Description:</b> Roof Panel		<b>Length</b>	803mm	<b>Quantity</b>	6	<b>Description:</b> Roof Panel		<table border="1"> <tr> <td><b>PRODUCT ID</b></td> <td><b>M</b></td> <td rowspan="4">  </td> </tr> <tr> <td><b>Length</b></td> <td>2099mm</td> </tr> <tr> <td><b>Quantity</b></td> <td>4</td> </tr> <tr> <td colspan="2"><b>Description:</b> Top/Bottom Front/Rear Channel</td> </tr> </table>	<b>PRODUCT ID</b>	<b>M</b>		<b>Length</b>	2099mm	<b>Quantity</b>	4	<b>Description:</b> Top/Bottom Front/Rear Channel	
<b>PRODUCT ID</b>	<b>E</b>			<table border="1"> <tr> <td><b>PRODUCT ID</b></td> <td><b>M</b></td> <td rowspan="4">  </td> </tr> <tr> <td><b>Length</b></td> <td>803mm</td> </tr> <tr> <td><b>Quantity</b></td> <td>6</td> </tr> <tr> <td colspan="2"><b>Description:</b> Roof Panel</td> </tr> </table>	<b>PRODUCT ID</b>	<b>M</b>			<b>Length</b>	803mm	<b>Quantity</b>	6	<b>Description:</b> Roof Panel																
<b>PRODUCT ID</b>	<b>M</b>																												
<b>Length</b>	803mm																												
<b>Quantity</b>	6																												
<b>Description:</b> Roof Panel																													
<b>Length</b>	803mm																												
<b>Quantity</b>	6																												
<b>Description:</b> Roof Panel																													
<b>PRODUCT ID</b>	<b>M</b>																												
<b>Length</b>	2099mm																												
<b>Quantity</b>	4																												
<b>Description:</b> Top/Bottom Front/Rear Channel																													
<table border="1"> <tr> <td><b>PRODUCT ID</b></td> <td><b>F</b></td> <td rowspan="4">  </td> <td> <table border="1"> <tr> <td><b>PRODUCT ID</b></td> <td><b>N</b></td> <td rowspan="4">  </td> </tr> <tr> <td><b>Length</b></td> <td>1738mm</td> </tr> <tr> <td><b>Quantity</b></td> <td>4</td> </tr> <tr> <td colspan="2"><b>Description:</b> Door Panel Side (partially slit)</td> </tr> </table> </td> </tr> <tr> <td><b>Length</b></td> <td>1738mm</td> </tr> <tr> <td><b>Quantity</b></td> <td>4</td> </tr> <tr> <td colspan="2"><b>Description:</b> Door Panel Side (partially slit)</td> </tr> </table>	<b>PRODUCT ID</b>	<b>F</b>		<table border="1"> <tr> <td><b>PRODUCT ID</b></td> <td><b>N</b></td> <td rowspan="4">  </td> </tr> <tr> <td><b>Length</b></td> <td>1738mm</td> </tr> <tr> <td><b>Quantity</b></td> <td>4</td> </tr> <tr> <td colspan="2"><b>Description:</b> Door Panel Side (partially slit)</td> </tr> </table>	<b>PRODUCT ID</b>	<b>N</b>		<b>Length</b>	1738mm	<b>Quantity</b>	4	<b>Description:</b> Door Panel Side (partially slit)		<b>Length</b>	1738mm	<b>Quantity</b>	4	<b>Description:</b> Door Panel Side (partially slit)		<table border="1"> <tr> <td><b>PRODUCT ID</b></td> <td><b>N</b></td> <td rowspan="4">  </td> </tr> <tr> <td><b>Length</b></td> <td>715mm</td> </tr> <tr> <td><b>Quantity</b></td> <td>4</td> </tr> <tr> <td colspan="2"><b>Description:</b> Side Channel Top/Bottom</td> </tr> </table>	<b>PRODUCT ID</b>	<b>N</b>		<b>Length</b>	715mm	<b>Quantity</b>	4	<b>Description:</b> Side Channel Top/Bottom	
<b>PRODUCT ID</b>	<b>F</b>			<table border="1"> <tr> <td><b>PRODUCT ID</b></td> <td><b>N</b></td> <td rowspan="4">  </td> </tr> <tr> <td><b>Length</b></td> <td>1738mm</td> </tr> <tr> <td><b>Quantity</b></td> <td>4</td> </tr> <tr> <td colspan="2"><b>Description:</b> Door Panel Side (partially slit)</td> </tr> </table>	<b>PRODUCT ID</b>	<b>N</b>			<b>Length</b>	1738mm	<b>Quantity</b>	4	<b>Description:</b> Door Panel Side (partially slit)																
<b>PRODUCT ID</b>	<b>N</b>																												
<b>Length</b>	1738mm																												
<b>Quantity</b>	4																												
<b>Description:</b> Door Panel Side (partially slit)																													
<b>Length</b>	1738mm																												
<b>Quantity</b>	4																												
<b>Description:</b> Door Panel Side (partially slit)																													
<b>PRODUCT ID</b>	<b>N</b>																												
<b>Length</b>	715mm																												
<b>Quantity</b>	4																												
<b>Description:</b> Side Channel Top/Bottom																													
<table border="1"> <tr> <td><b>PRODUCT ID</b></td> <td><b>H</b></td> <td rowspan="4">  </td> <td> <table border="1"> <tr> <td><b>PRODUCT ID</b></td> <td><b>Q</b></td> <td rowspan="4">  </td> </tr> <tr> <td><b>Length</b></td> <td>674mm</td> </tr> <tr> <td><b>Quantity</b></td> <td>4</td> </tr> <tr> <td colspan="2"><b>Description:</b> Door Frame Top/Bottom</td> </tr> </table> </td> </tr> <tr> <td><b>Length</b></td> <td>674mm</td> </tr> <tr> <td><b>Quantity</b></td> <td>4</td> </tr> <tr> <td colspan="2"><b>Description:</b> Door Frame Top/Bottom</td> </tr> </table>	<b>PRODUCT ID</b>	<b>H</b>		<table border="1"> <tr> <td><b>PRODUCT ID</b></td> <td><b>Q</b></td> <td rowspan="4">  </td> </tr> <tr> <td><b>Length</b></td> <td>674mm</td> </tr> <tr> <td><b>Quantity</b></td> <td>4</td> </tr> <tr> <td colspan="2"><b>Description:</b> Door Frame Top/Bottom</td> </tr> </table>	<b>PRODUCT ID</b>	<b>Q</b>		<b>Length</b>	674mm	<b>Quantity</b>	4	<b>Description:</b> Door Frame Top/Bottom		<b>Length</b>	674mm	<b>Quantity</b>	4	<b>Description:</b> Door Frame Top/Bottom		<table border="1"> <tr> <td><b>PRODUCT ID</b></td> <td><b>Q</b></td> <td rowspan="4">  </td> </tr> <tr> <td><b>Length</b></td> <td>1800mm</td> </tr> <tr> <td><b>Quantity</b></td> <td>2</td> </tr> <tr> <td colspan="2"><b>Description:</b> Door Jamb</td> </tr> </table>	<b>PRODUCT ID</b>	<b>Q</b>		<b>Length</b>	1800mm	<b>Quantity</b>	2	<b>Description:</b> Door Jamb	
<b>PRODUCT ID</b>	<b>H</b>			<table border="1"> <tr> <td><b>PRODUCT ID</b></td> <td><b>Q</b></td> <td rowspan="4">  </td> </tr> <tr> <td><b>Length</b></td> <td>674mm</td> </tr> <tr> <td><b>Quantity</b></td> <td>4</td> </tr> <tr> <td colspan="2"><b>Description:</b> Door Frame Top/Bottom</td> </tr> </table>	<b>PRODUCT ID</b>	<b>Q</b>			<b>Length</b>	674mm	<b>Quantity</b>	4	<b>Description:</b> Door Frame Top/Bottom																
<b>PRODUCT ID</b>	<b>Q</b>																												
<b>Length</b>	674mm																												
<b>Quantity</b>	4																												
<b>Description:</b> Door Frame Top/Bottom																													
<b>Length</b>	674mm																												
<b>Quantity</b>	4																												
<b>Description:</b> Door Frame Top/Bottom																													
<b>PRODUCT ID</b>	<b>Q</b>																												
<b>Length</b>	1800mm																												
<b>Quantity</b>	2																												
<b>Description:</b> Door Jamb																													
<table border="1"> <tr> <td><b>PRODUCT ID</b></td> <td><b>I</b></td> <td rowspan="4">  </td> <td> <table border="1"> <tr> <td><b>PRODUCT ID</b></td> <td><b>R</b></td> <td rowspan="4">  </td> </tr> <tr> <td><b>Length</b></td> <td>1742mm</td> </tr> <tr> <td><b>Quantity</b></td> <td>4</td> </tr> <tr> <td colspan="2"><b>Description:</b> Door Frame Side</td> </tr> </table> </td> </tr> <tr> <td><b>Length</b></td> <td>1742mm</td> </tr> <tr> <td><b>Quantity</b></td> <td>4</td> </tr> <tr> <td colspan="2"><b>Description:</b> Door Frame Side</td> </tr> </table>	<b>PRODUCT ID</b>	<b>I</b>		<table border="1"> <tr> <td><b>PRODUCT ID</b></td> <td><b>R</b></td> <td rowspan="4">  </td> </tr> <tr> <td><b>Length</b></td> <td>1742mm</td> </tr> <tr> <td><b>Quantity</b></td> <td>4</td> </tr> <tr> <td colspan="2"><b>Description:</b> Door Frame Side</td> </tr> </table>	<b>PRODUCT ID</b>	<b>R</b>		<b>Length</b>	1742mm	<b>Quantity</b>	4	<b>Description:</b> Door Frame Side		<b>Length</b>	1742mm	<b>Quantity</b>	4	<b>Description:</b> Door Frame Side		<table border="1"> <tr> <td><b>PRODUCT ID</b></td> <td><b>R</b></td> <td rowspan="4">  </td> </tr> <tr> <td><b>Length</b></td> <td>1367mm</td> </tr> <tr> <td><b>Quantity</b></td> <td>1</td> </tr> <tr> <td colspan="2"><b>Description:</b> Bottom Door Spacer</td> </tr> </table>	<b>PRODUCT ID</b>	<b>R</b>		<b>Length</b>	1367mm	<b>Quantity</b>	1	<b>Description:</b> Bottom Door Spacer	
<b>PRODUCT ID</b>	<b>I</b>			<table border="1"> <tr> <td><b>PRODUCT ID</b></td> <td><b>R</b></td> <td rowspan="4">  </td> </tr> <tr> <td><b>Length</b></td> <td>1742mm</td> </tr> <tr> <td><b>Quantity</b></td> <td>4</td> </tr> <tr> <td colspan="2"><b>Description:</b> Door Frame Side</td> </tr> </table>	<b>PRODUCT ID</b>	<b>R</b>			<b>Length</b>	1742mm	<b>Quantity</b>	4	<b>Description:</b> Door Frame Side																
<b>PRODUCT ID</b>	<b>R</b>																												
<b>Length</b>	1742mm																												
<b>Quantity</b>	4																												
<b>Description:</b> Door Frame Side																													
<b>Length</b>	1742mm																												
<b>Quantity</b>	4																												
<b>Description:</b> Door Frame Side																													
<b>PRODUCT ID</b>	<b>R</b>																												
<b>Length</b>	1367mm																												
<b>Quantity</b>	1																												
<b>Description:</b> Bottom Door Spacer																													
<table border="1"> <tr> <td><b>PRODUCT ID</b></td> <td><b>J</b></td> <td rowspan="4">  </td> <td> <table border="1"> <tr> <td><b>PRODUCT ID</b></td> <td><b>S</b></td> <td rowspan="4">  </td> </tr> <tr> <td><b>Length</b></td> <td>1706mm</td> </tr> <tr> <td><b>Quantity</b></td> <td>4</td> </tr> <tr> <td colspan="2"><b>Description:</b> Door Boxing</td> </tr> </table> </td> </tr> <tr> <td><b>Length</b></td> <td>1706mm</td> </tr> <tr> <td><b>Quantity</b></td> <td>4</td> </tr> <tr> <td colspan="2"><b>Description:</b> Door Boxing</td> </tr> </table>	<b>PRODUCT ID</b>	<b>J</b>		<table border="1"> <tr> <td><b>PRODUCT ID</b></td> <td><b>S</b></td> <td rowspan="4">  </td> </tr> <tr> <td><b>Length</b></td> <td>1706mm</td> </tr> <tr> <td><b>Quantity</b></td> <td>4</td> </tr> <tr> <td colspan="2"><b>Description:</b> Door Boxing</td> </tr> </table>	<b>PRODUCT ID</b>	<b>S</b>		<b>Length</b>	1706mm	<b>Quantity</b>	4	<b>Description:</b> Door Boxing		<b>Length</b>	1706mm	<b>Quantity</b>	4	<b>Description:</b> Door Boxing		<table border="1"> <tr> <td><b>PRODUCT ID</b></td> <td><b>S</b></td> <td rowspan="4">  </td> </tr> <tr> <td><b>Length</b></td> <td>1367mm</td> </tr> <tr> <td><b>Quantity</b></td> <td>1</td> </tr> <tr> <td colspan="2"><b>Description:</b> Top Door Spacer</td> </tr> </table>	<b>PRODUCT ID</b>	<b>S</b>		<b>Length</b>	1367mm	<b>Quantity</b>	1	<b>Description:</b> Top Door Spacer	
<b>PRODUCT ID</b>	<b>J</b>			<table border="1"> <tr> <td><b>PRODUCT ID</b></td> <td><b>S</b></td> <td rowspan="4">  </td> </tr> <tr> <td><b>Length</b></td> <td>1706mm</td> </tr> <tr> <td><b>Quantity</b></td> <td>4</td> </tr> <tr> <td colspan="2"><b>Description:</b> Door Boxing</td> </tr> </table>	<b>PRODUCT ID</b>	<b>S</b>			<b>Length</b>	1706mm	<b>Quantity</b>	4	<b>Description:</b> Door Boxing																
<b>PRODUCT ID</b>	<b>S</b>																												
<b>Length</b>	1706mm																												
<b>Quantity</b>	4																												
<b>Description:</b> Door Boxing																													
<b>Length</b>	1706mm																												
<b>Quantity</b>	4																												
<b>Description:</b> Door Boxing																													
<b>PRODUCT ID</b>	<b>S</b>																												
<b>Length</b>	1367mm																												
<b>Quantity</b>	1																												
<b>Description:</b> Top Door Spacer																													

# PARTS LIST

<table border="1"> <tr> <td><b>PRODUCT ID</b></td> <td>V</td> </tr> <tr> <td><b>Length</b></td> <td>2096mm</td> </tr> <tr> <td><b>Quantity</b></td> <td>2</td> </tr> <tr> <td><b>Description:</b></td> <td>Gutter Trim</td> </tr> </table>	<b>PRODUCT ID</b>	V	<b>Length</b>	2096mm	<b>Quantity</b>	2	<b>Description:</b>	Gutter Trim		<table border="1"> <tr> <td><b>Quantity</b></td> <td>3</td> </tr> <tr> <td><b>Description:</b></td> <td>Padbolt</td> </tr> </table>	<b>Quantity</b>	3	<b>Description:</b>	Padbolt	
<b>PRODUCT ID</b>	V														
<b>Length</b>	2096mm														
<b>Quantity</b>	2														
<b>Description:</b>	Gutter Trim														
<b>Quantity</b>	3														
<b>Description:</b>	Padbolt														
<table border="1"> <tr> <td><b>PRODUCT ID</b></td> <td>W</td> </tr> <tr> <td><b>Length</b></td> <td>795mm</td> </tr> <tr> <td><b>Quantity</b></td> <td>2</td> </tr> <tr> <td><b>Description:</b></td> <td>Roof Angle Trim</td> </tr> </table>	<b>PRODUCT ID</b>	W	<b>Length</b>	795mm	<b>Quantity</b>	2	<b>Description:</b>	Roof Angle Trim		<table border="1"> <tr> <td><b>Quantity</b></td> <td>2</td> </tr> <tr> <td><b>Description:</b></td> <td>Keeper</td> </tr> </table>	<b>Quantity</b>	2	<b>Description:</b>	Keeper	
<b>PRODUCT ID</b>	W														
<b>Length</b>	795mm														
<b>Quantity</b>	2														
<b>Description:</b>	Roof Angle Trim														
<b>Quantity</b>	2														
<b>Description:</b>	Keeper														
<table border="1"> <tr> <td><b>Quantity</b></td> <td>4</td> </tr> <tr> <td><b>Description:</b></td> <td>Hinges (offset)</td> </tr> </table>	<b>Quantity</b>	4	<b>Description:</b>	Hinges (offset)		<table border="1"> <tr> <td><b>Quantity</b></td> <td>1</td> </tr> <tr> <td><b>Description:</b></td> <td>Plastic Washer and Screw Cap Sheet</td> </tr> </table>	<b>Quantity</b>	1	<b>Description:</b>	Plastic Washer and Screw Cap Sheet					
<b>Quantity</b>	4														
<b>Description:</b>	Hinges (offset)														
<b>Quantity</b>	1														
<b>Description:</b>	Plastic Washer and Screw Cap Sheet														
<table border="1"> <tr> <td><b>Quantity</b></td> <td>200</td> </tr> <tr> <td><b>Description:</b></td> <td>Self Tapping Screws - Silver</td> </tr> </table>	<b>Quantity</b>	200	<b>Description:</b>	Self Tapping Screws - Silver		<table border="1"> <tr> <td><b>Quantity</b></td> <td>4</td> </tr> <tr> <td><b>Description:</b></td> <td>Plastic Corner Cap</td> </tr> </table>	<b>Quantity</b>	4	<b>Description:</b>	Plastic Corner Cap					
<b>Quantity</b>	200														
<b>Description:</b>	Self Tapping Screws - Silver														
<b>Quantity</b>	4														
<b>Description:</b>	Plastic Corner Cap														
<table border="1"> <tr> <td><b>Quantity</b></td> <td>1</td> </tr> <tr> <td><b>Description:</b></td> <td>2.5mm Drill Bit</td> </tr> </table>	<b>Quantity</b>	1	<b>Description:</b>	2.5mm Drill Bit		<table border="1"> <tr> <td><b>Quantity</b></td> <td>4</td> </tr> <tr> <td><b>Description:</b></td> <td>Corner Bracket</td> </tr> </table>	<b>Quantity</b>	4	<b>Description:</b>	Corner Bracket					
<b>Quantity</b>	1														
<b>Description:</b>	2.5mm Drill Bit														
<b>Quantity</b>	4														
<b>Description:</b>	Corner Bracket														
<table border="1"> <tr> <td><b>Quantity</b></td> <td>2</td> </tr> <tr> <td><b>Description:</b></td> <td>Clip Nut</td> </tr> </table>	<b>Quantity</b>	2	<b>Description:</b>	Clip Nut		<table border="1"> <tr> <td><b>Quantity</b></td> <td>3</td> </tr> <tr> <td><b>Description:</b></td> <td>55mm Bracket</td> </tr> </table>	<b>Quantity</b>	3	<b>Description:</b>	55mm Bracket					
<b>Quantity</b>	2														
<b>Description:</b>	Clip Nut														
<b>Quantity</b>	3														
<b>Description:</b>	55mm Bracket														
<table border="1"> <tr> <td><b>Quantity</b></td> <td>1</td> </tr> <tr> <td><b>Description:</b></td> <td>Door Plate</td> </tr> </table>	<b>Quantity</b>	1	<b>Description:</b>	Door Plate		<table border="1"> <tr> <td><b>Quantity</b></td> <td>6</td> </tr> <tr> <td><b>Description:</b></td> <td>3/16" Nut &amp; Bolt</td> </tr> </table>	<b>Quantity</b>	6	<b>Description:</b>	3/16" Nut & Bolt					
<b>Quantity</b>	1														
<b>Description:</b>	Door Plate														
<b>Quantity</b>	6														
<b>Description:</b>	3/16" Nut & Bolt														

# PARTS LIST

		
<b>Quantity</b>	<b>7</b>	
Masonry Anchor		

		
<b>Quantity</b>	<b>1</b>	
Phillips Head Bit		

# FOUNDATION

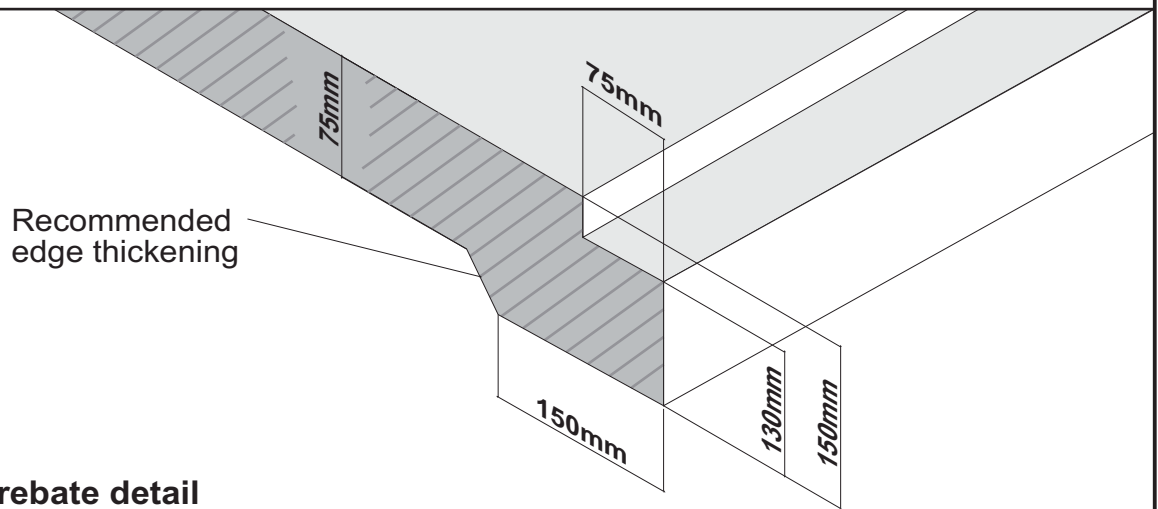

## Recommended slab rebate detail

Although *not required*, it is strongly recommended that, to avoid water leakage around the base of your shed, a rebate be cast into the slab. This will allow the shed to sit below the slab level and prevent water from reaching the upper level of the slab.

If you planning a rebated slab make sure to cut the 4 corners at  $125 \times 45^\circ$  as shown in detail below.

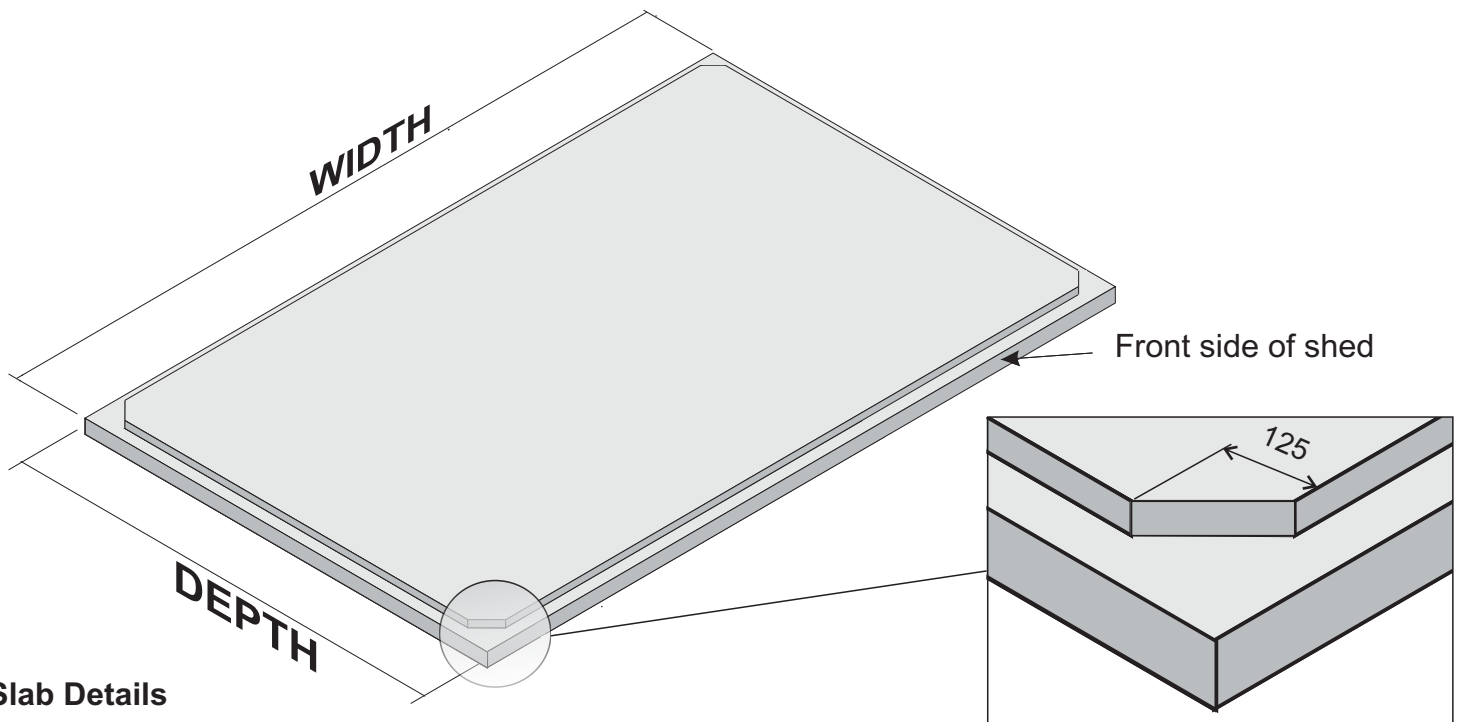

## Slab Details

Your garden shed must be erected on a solid, level and square foundation. We strongly recommend you pour a concrete slab 75mm thick, reinforced with SL62 mesh (minimum) using dimensions from the table below.

**\*Masonry anchors are supplied\***

SHED CODE	OUTER SLAB SIZE width x depth	ANCHORS M8 x 40mm
SL62-D	2205mmx820mm	6

# REAR WALL PANEL

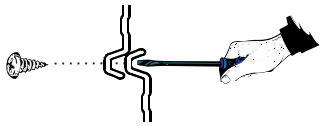

If you are having trouble screwing the channel to the sheets, chock behind the hole .

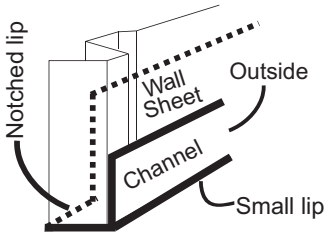

Ensure that the small lip of the channel is to the outside of the shed. Notched big lip is to inside

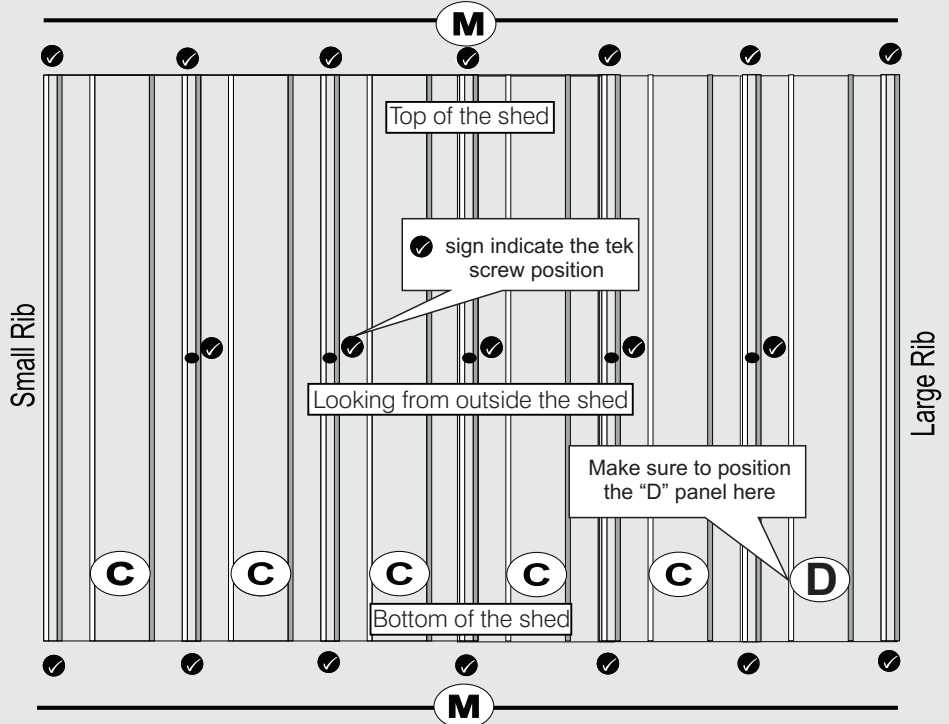

Fit the top and bottom channel to the wall panels. Ensure the large rib on the sheets are positioned as per the diagram above.  
NB: Some channel holes may not align perfectly when the sheets are laid out. They can be easily manipulated into position and screw to the channel.

1

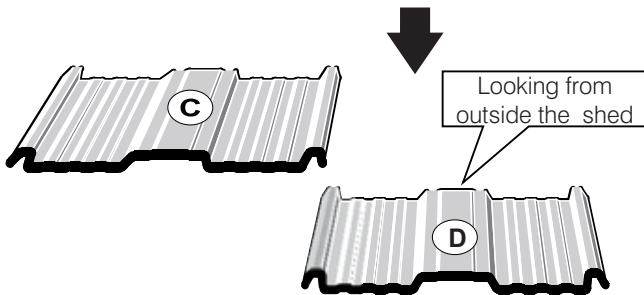

Lay the wall panels out with the large rib overlapping the small.

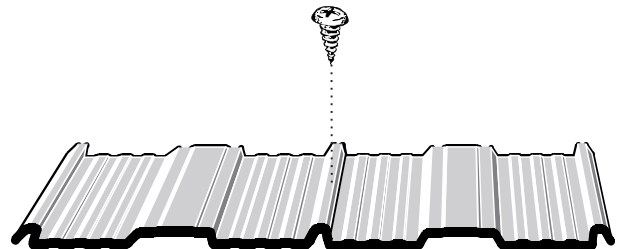

Screw the wall panels in the centre of the rib as shown.

2

Notched ends are orientated to the outer edges of the panel

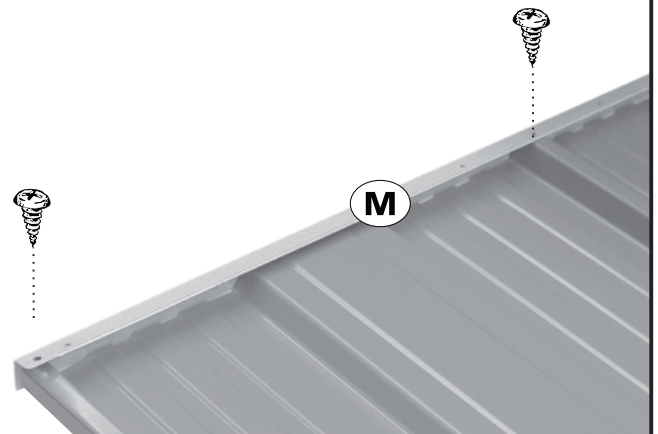
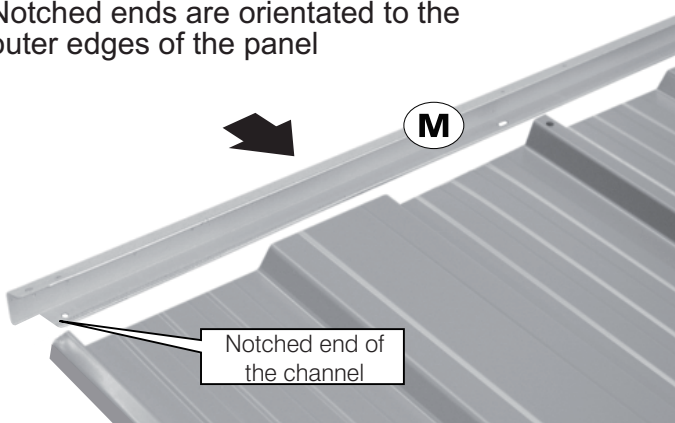

# FRONT WALL PANEL

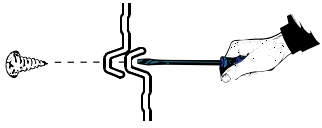

If you are having trouble screwing the channel to the sheets, chock behind the hole .

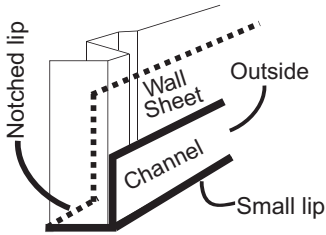

Ensure that the small lip of the channel is to the outside of the shed.  
Notched big lip is to inside

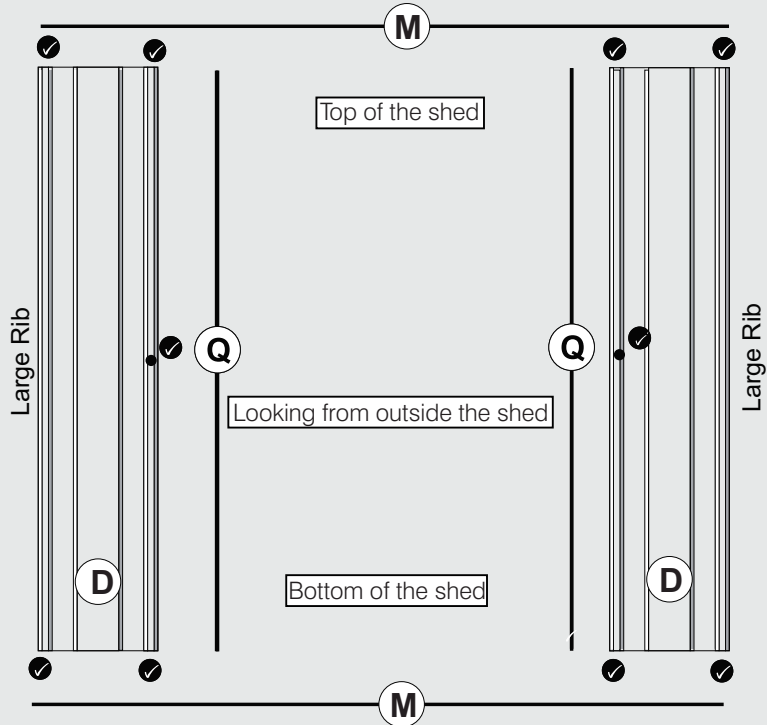
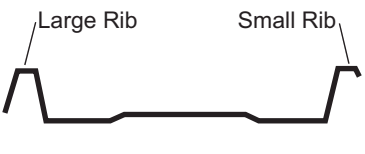

Fit the top and bottom channel and the door jambs to the wall panels.  
Ensure the large rib on the sheets are positioned as per the diagram above.  
NB: Some channel holes may not align perfectly when the sheets are laid out. They can be easily manipulated into position and screw to the channel.

1

Notched ends are orientated to the outer edges of the panel

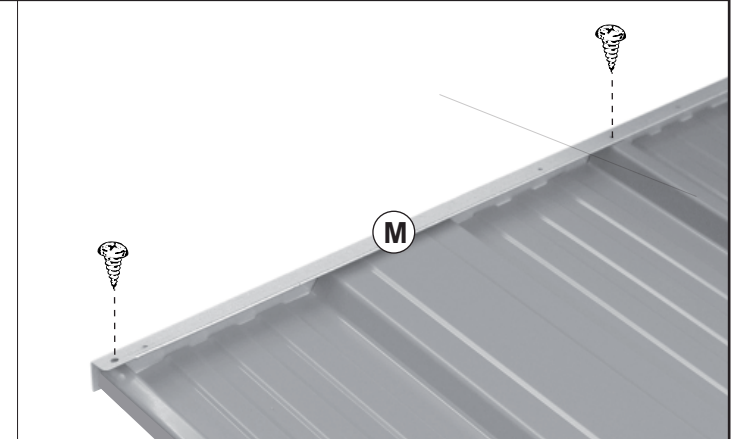
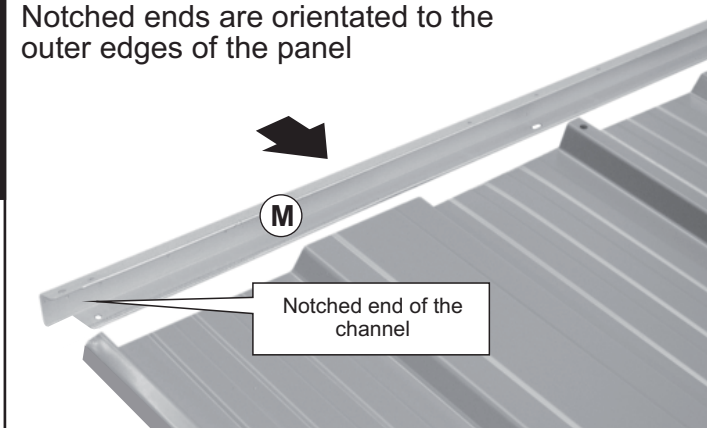

2

Top and bottom door jamb connection.

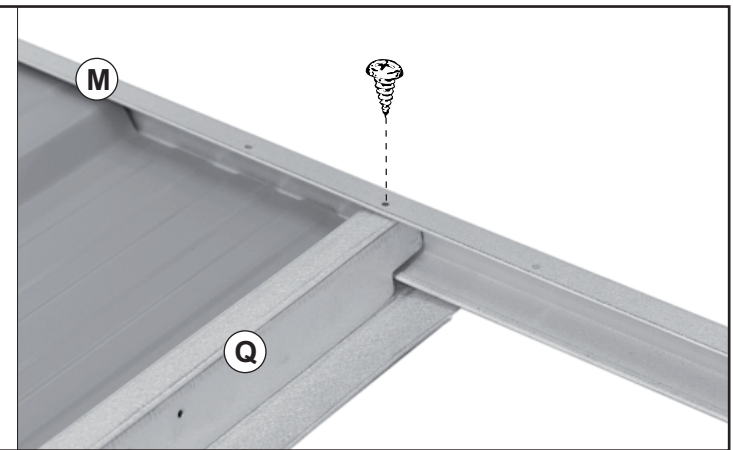
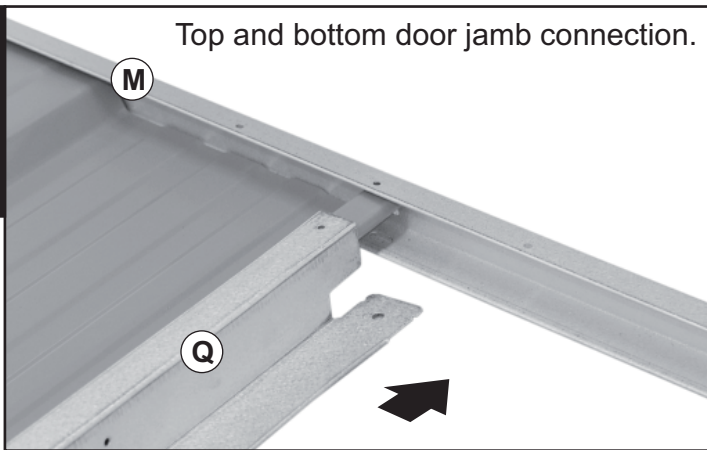

# FRONT WALL PANEL

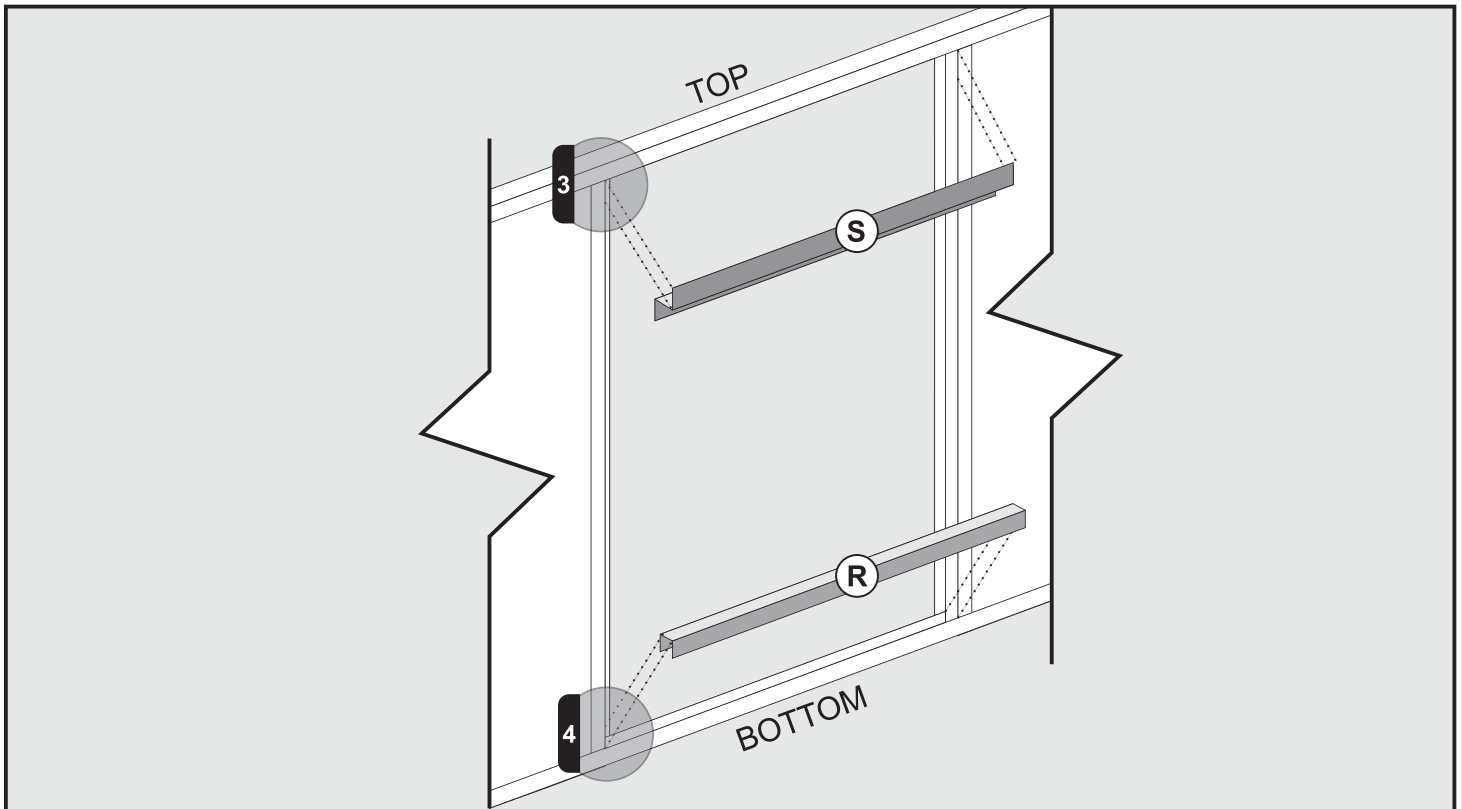

Fit the top door spacer and the bottom door spacer to the front wall panel as shown.

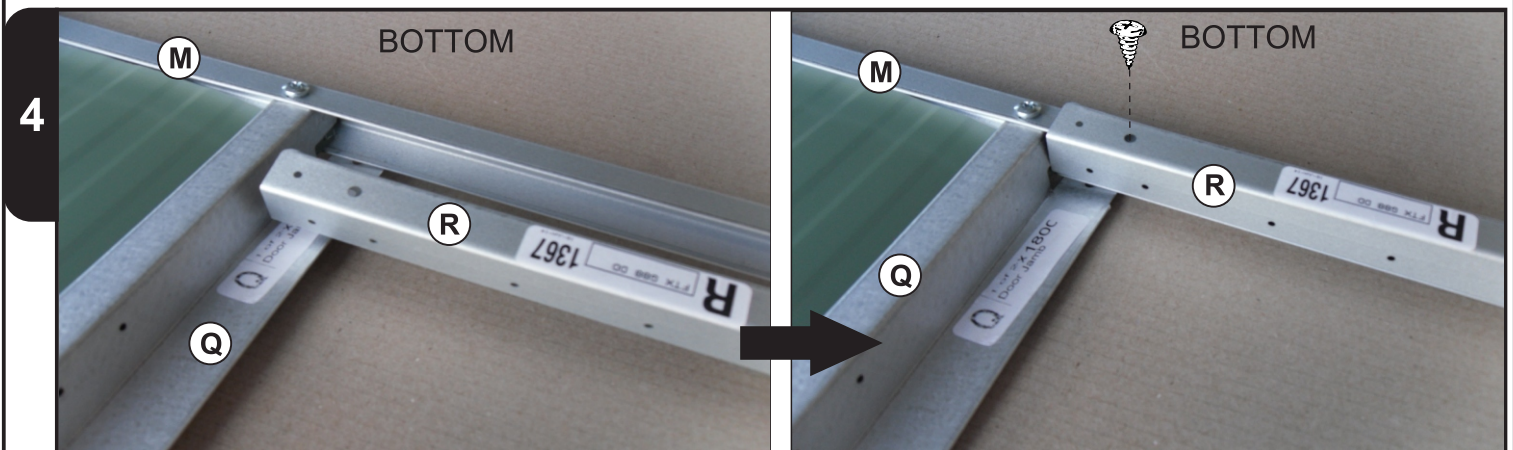
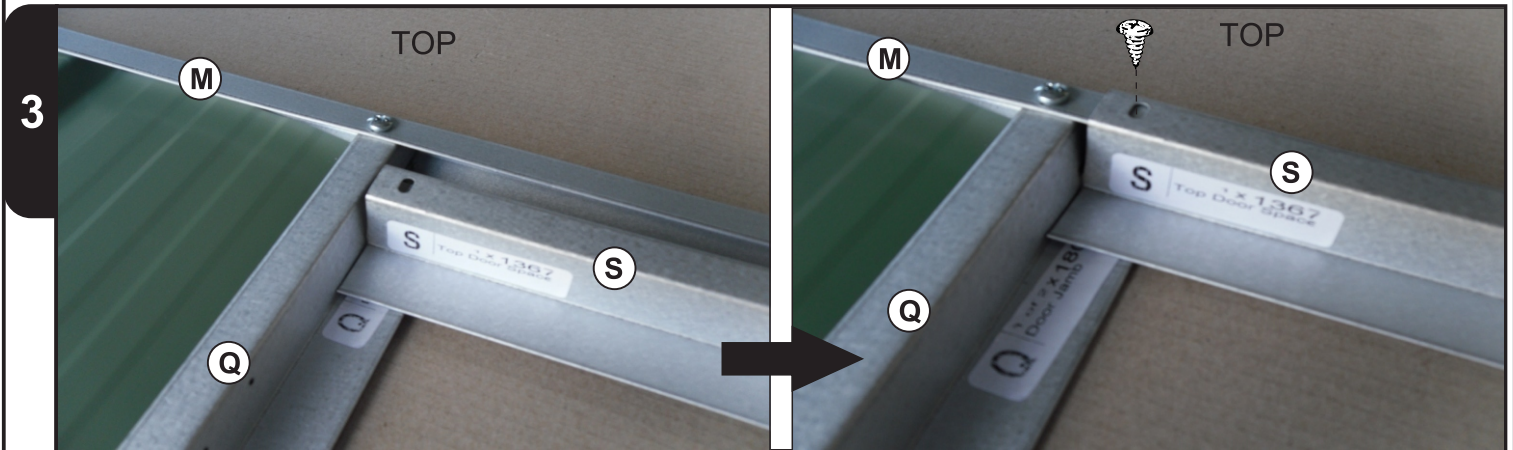

# FRONT WALL PANEL

5

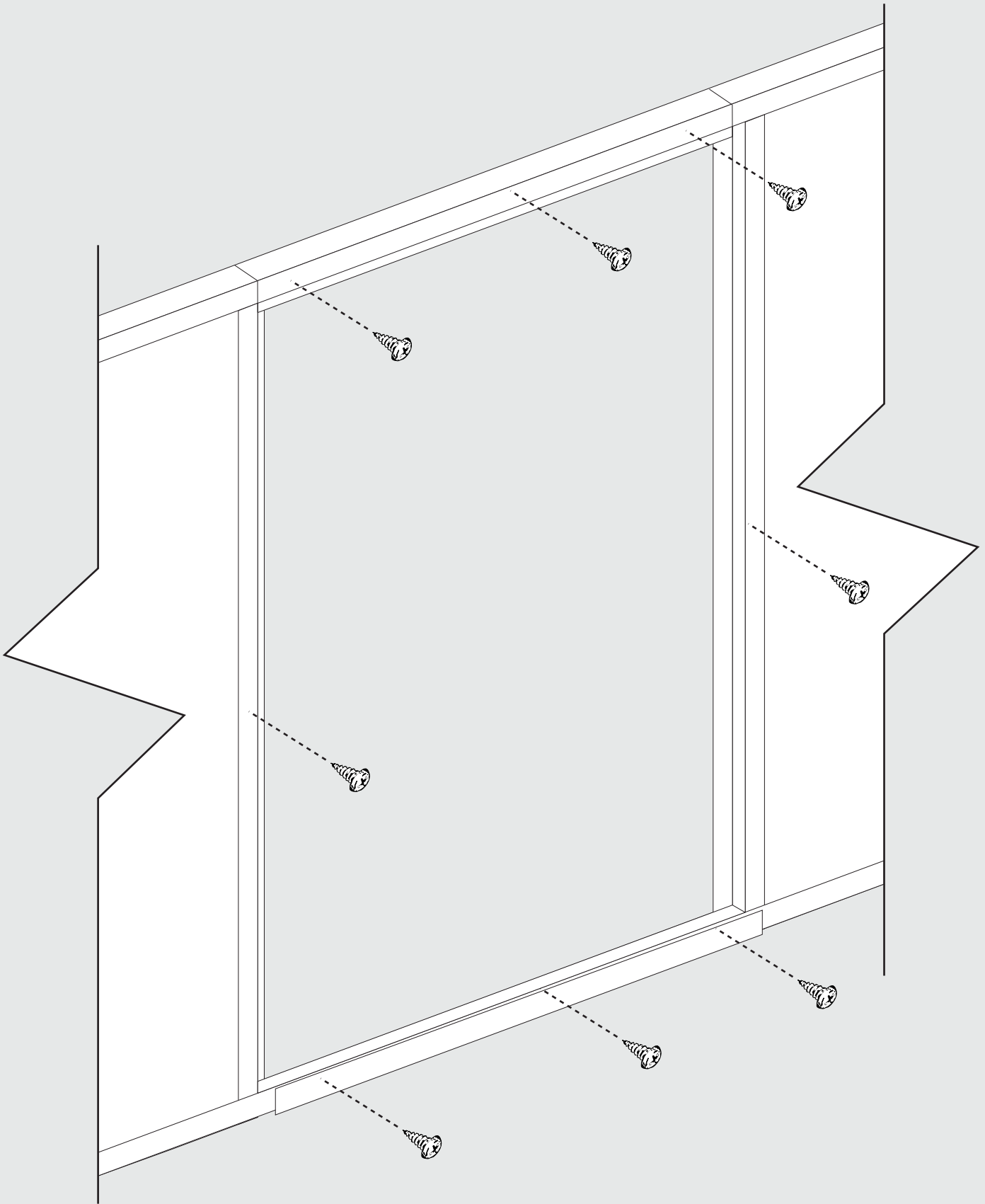

# SIDE WALL PANELS (2 REQUIRED)

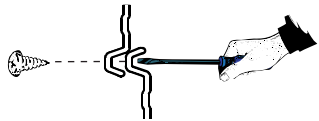

If you are having trouble screwing the channel to the sheets, chock behind the hole .

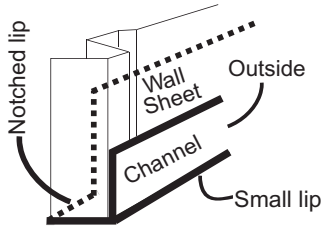

Ensure that the small lip of the channel is to the outside of the shed. Notched big lip is to inside

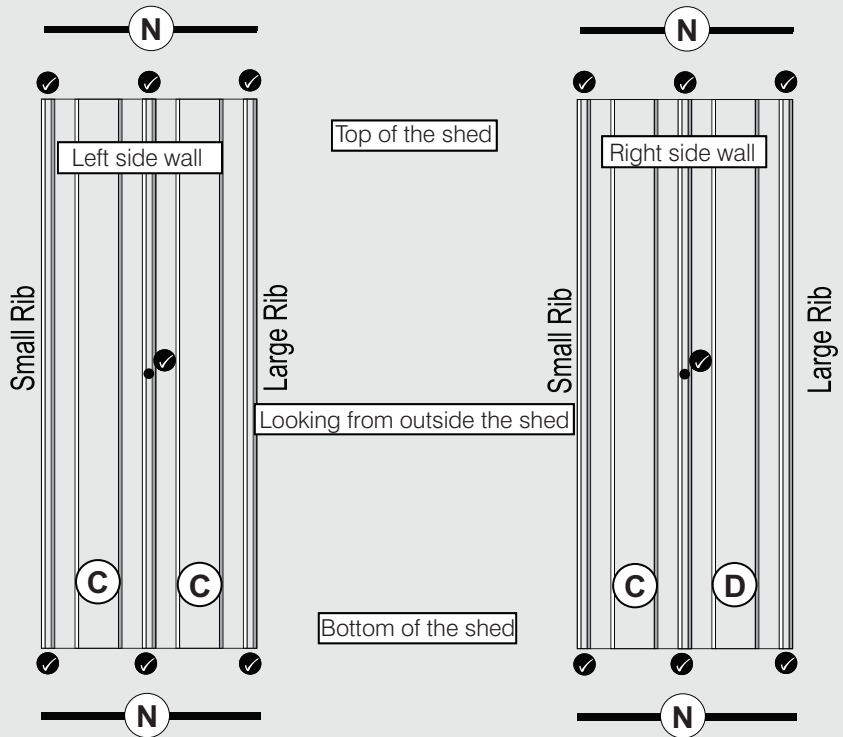

Fit the top and bottom channel to the wall panels. Ensure the channel is flush with the edge of the sheets.

1

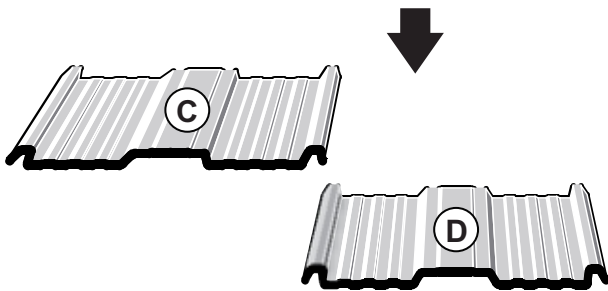

Lay the wall panels out with the large rib overlapping the small.

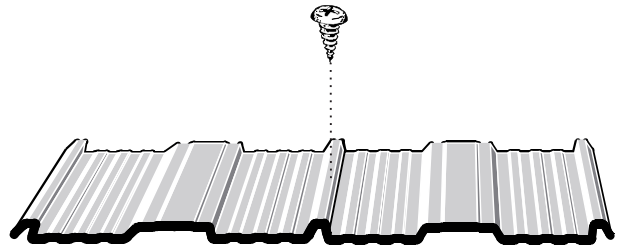

Screw the wall panels in the centre of the rib as shown.

2

Notched ends are orientated to the outer edges of the panel

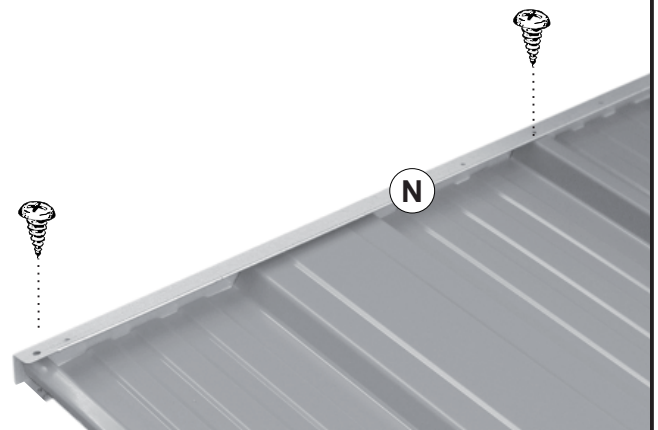
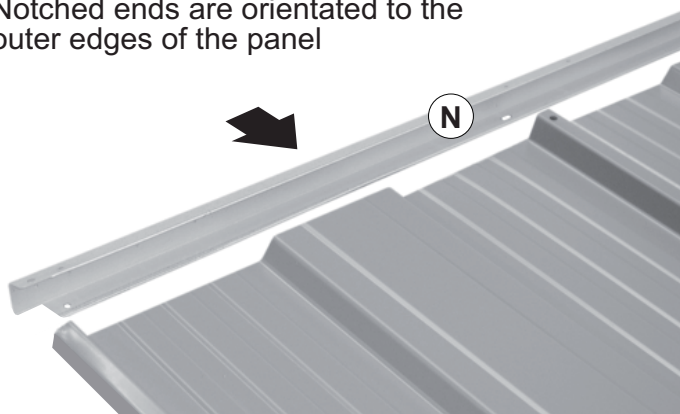

# STAND AND JOIN WALL PANELS

**NOTE:** The diagram below shows a 44 flat roof shed. The assembly process is the same for all flat roof sizes.

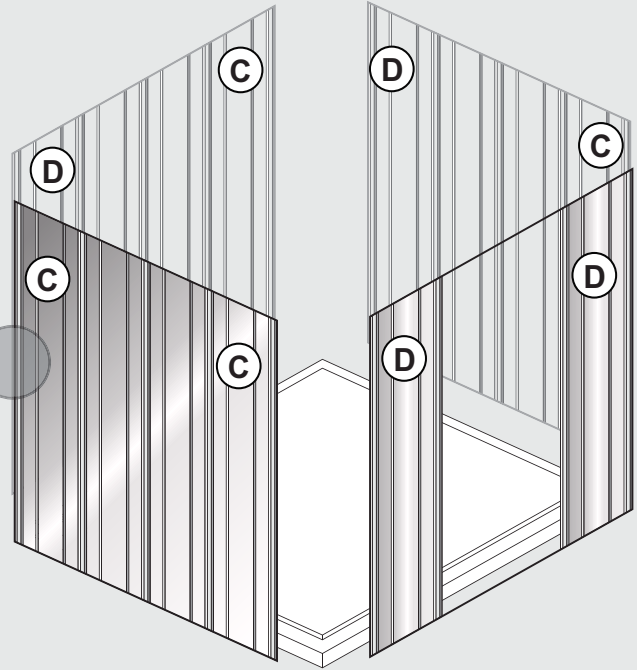
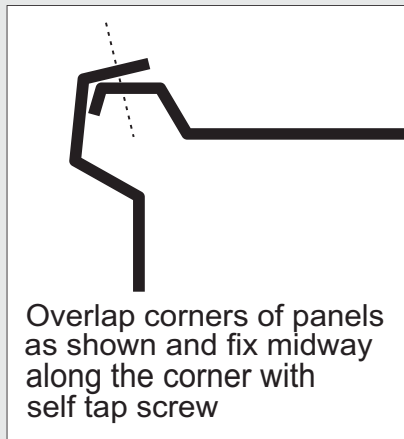

Once the four wall panels are assembled, they can now be stood and fixed together. Fix using the corner brackets and screws as shown below. Fix the front panel last. N.B when assembling large wall models, eg. 7 panels width and above, extra care should be taken, with person two providing adequate support to stop the wall from distorting.

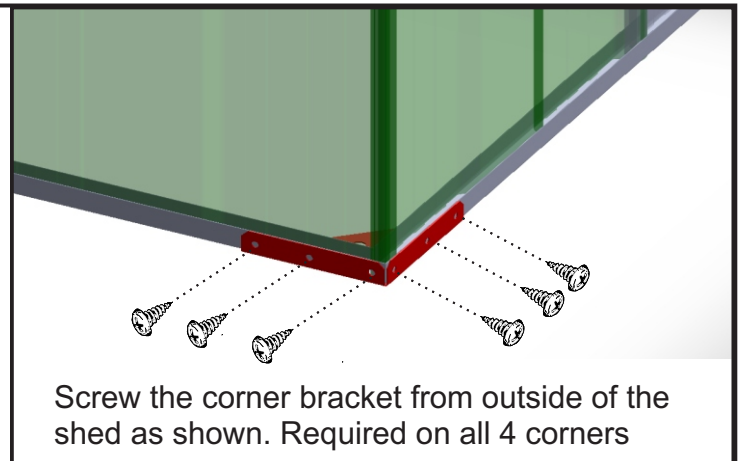
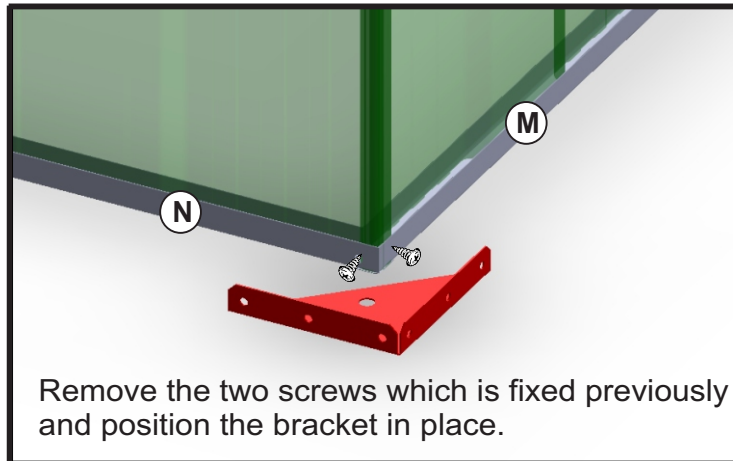
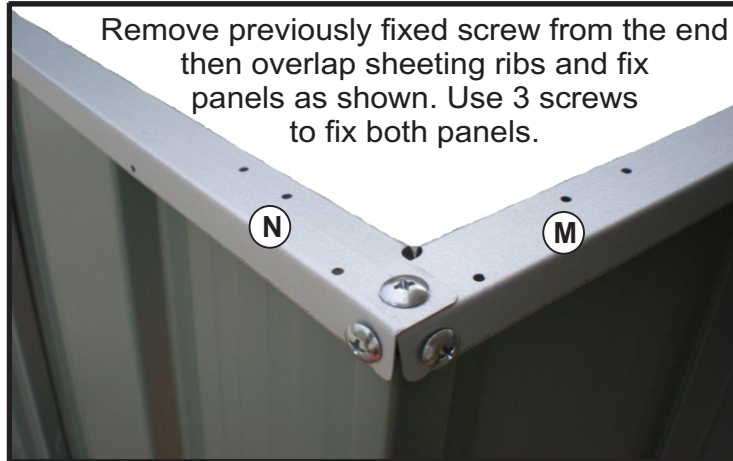

# FIT ROOF

1



**Step 1:** Place roof sheet on top, start from the left, big rib should flush with channel "N". Place all sheets as shown.

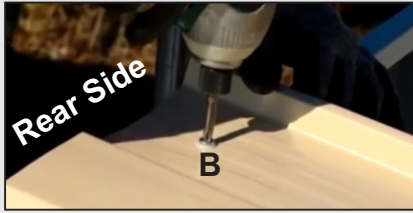

**Step 2:** Start from rear side. Screw all holes "B". Do not screw the hole "A" yet.



**Step 3:** Screw the front side through all holes "C". one screw per sheet.



**Step 4:** Screw the Rear side holes "A". You may either pre drill or use self drilling tek screw to fix this.

Two screw holes should be positioned on the rear side of the shed



Fit plastic washers to roof screws

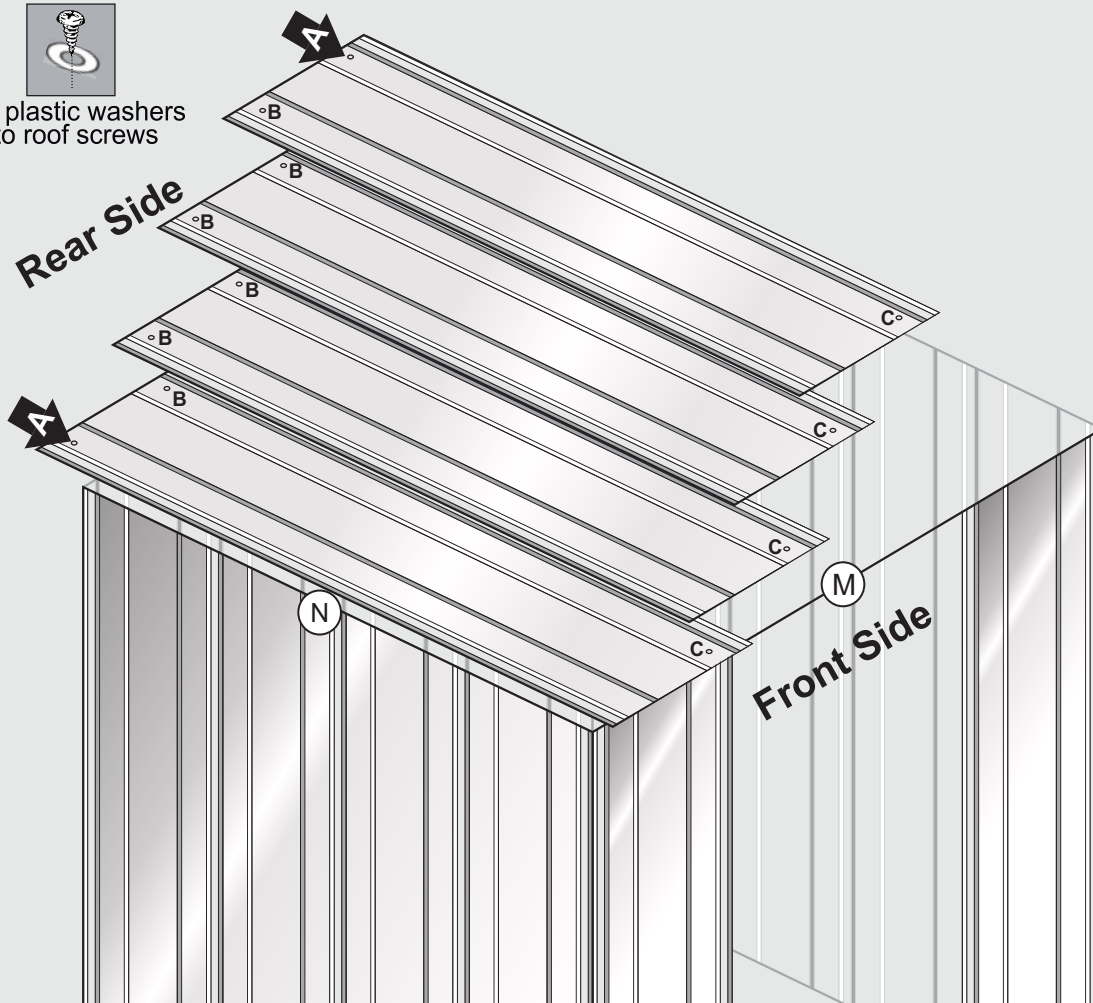

# FIT ROOF TRIMS

2

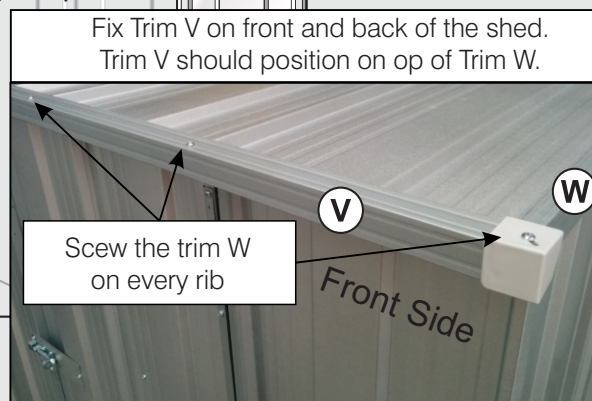
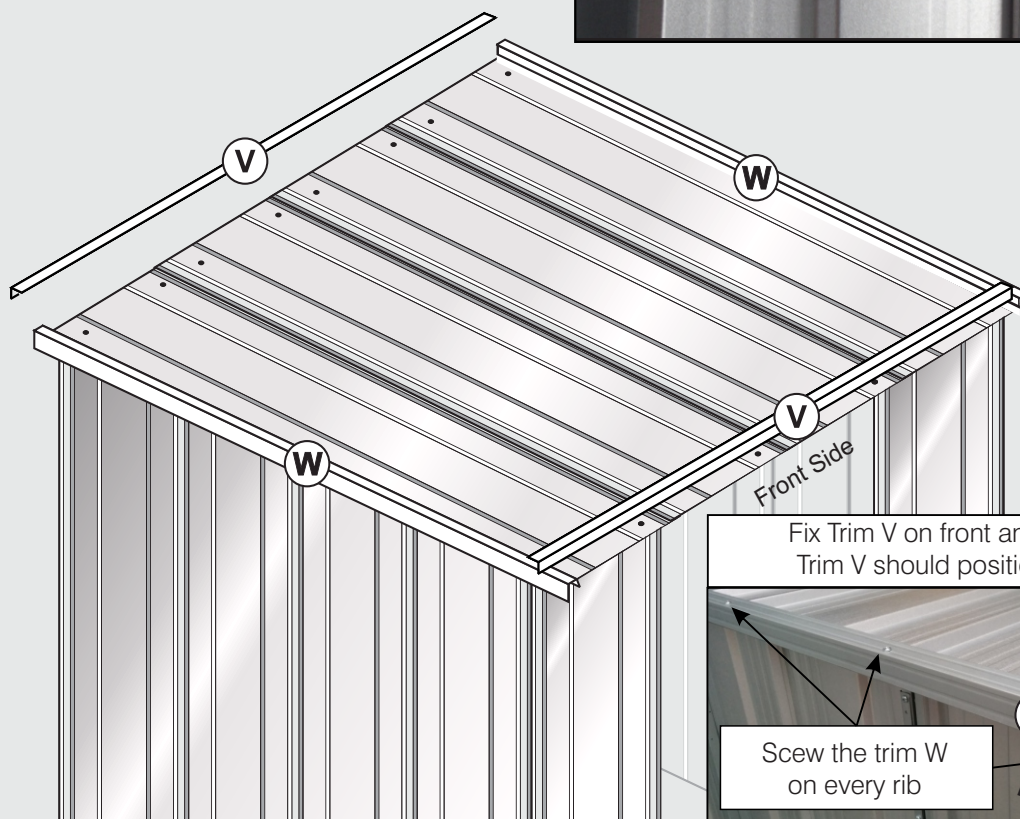
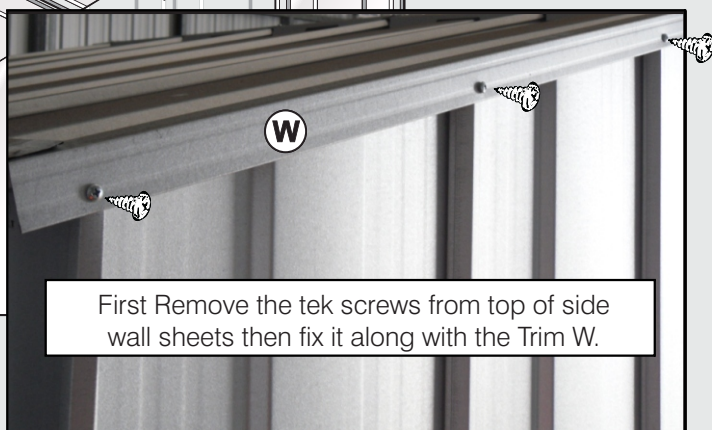
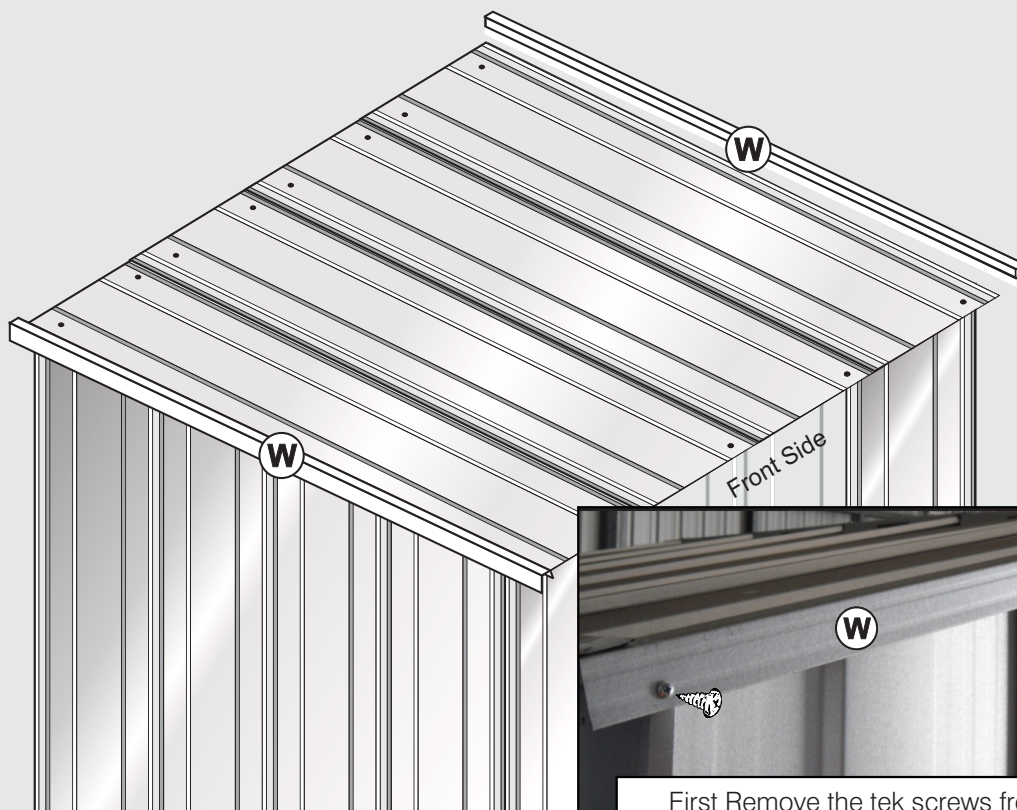

# ASSEMBLE DOOR

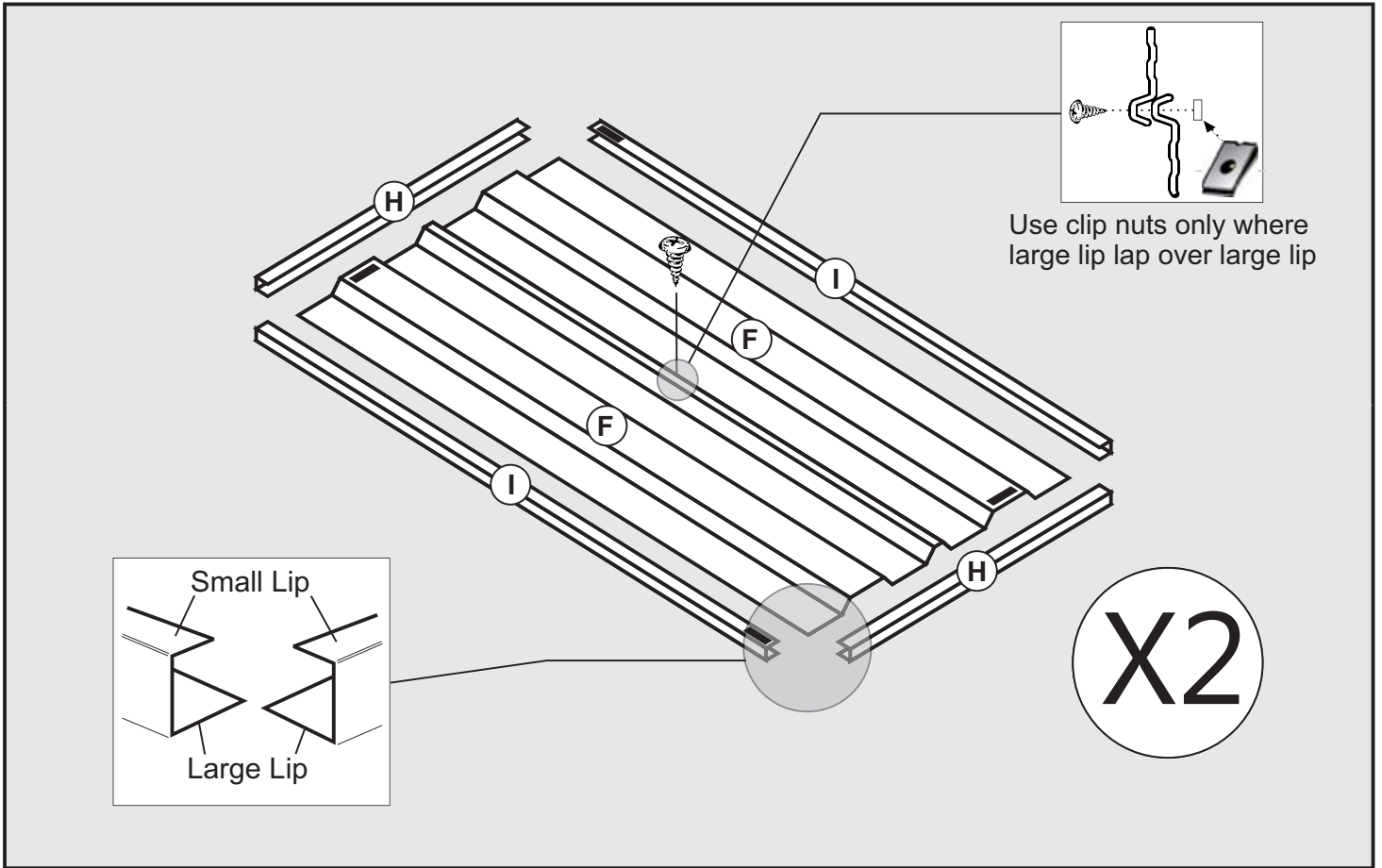

1

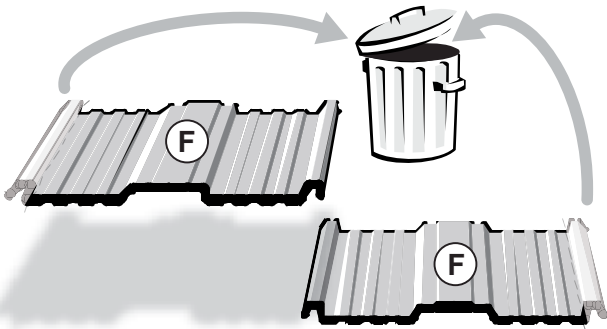

Both of the door sheets come with one rib partially slit. Break them off and discard them.

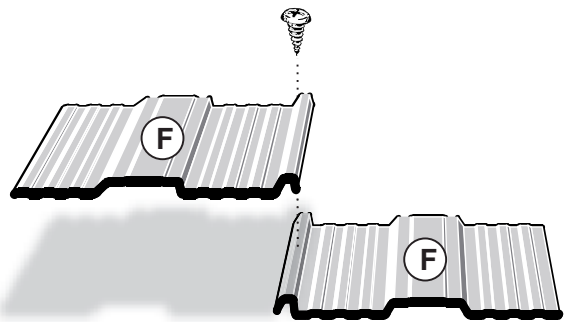

Screw the sheets in the center. Use clips nuts where ever required as per the above diagram

2

Frames slide under the sheet as shown. Ensure the small lip of the frame is to the top.



Fix door frames with a screw in each corner. Ensure that the big hole sits over the small.

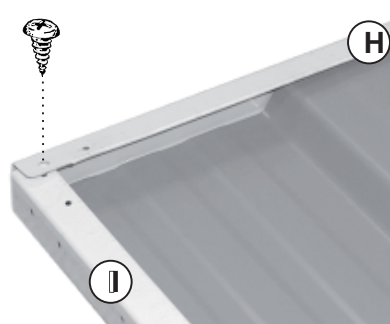

# ASSEMBLE DOOR

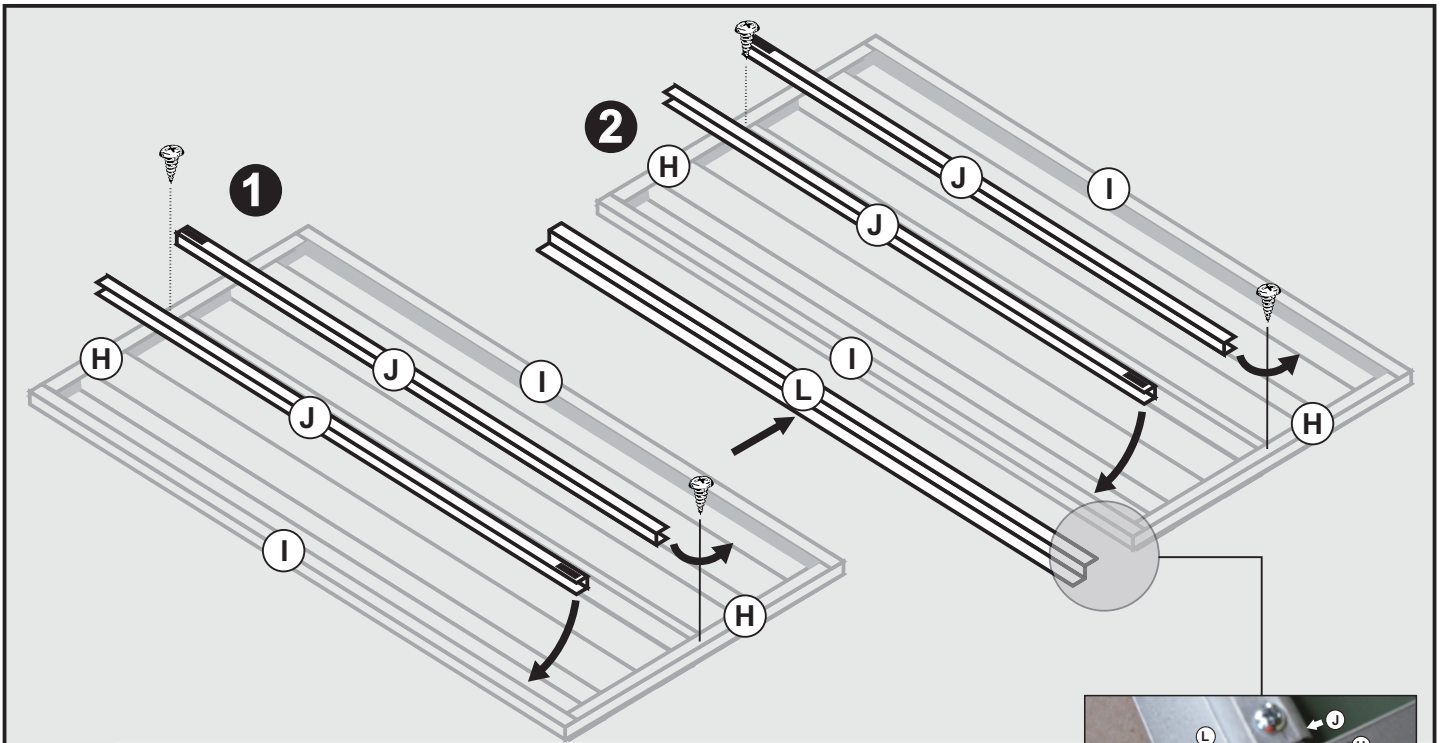

Fix the frame H to the sheeting with screws through the small channel lips into the large sheeting ribs. Door boxing "J" must be fitted to the door frames "I" and a door seal fitted on the door 2. The seal fits to the frame and boxing as shown to the right.

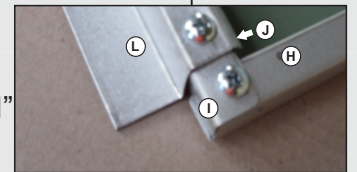

3

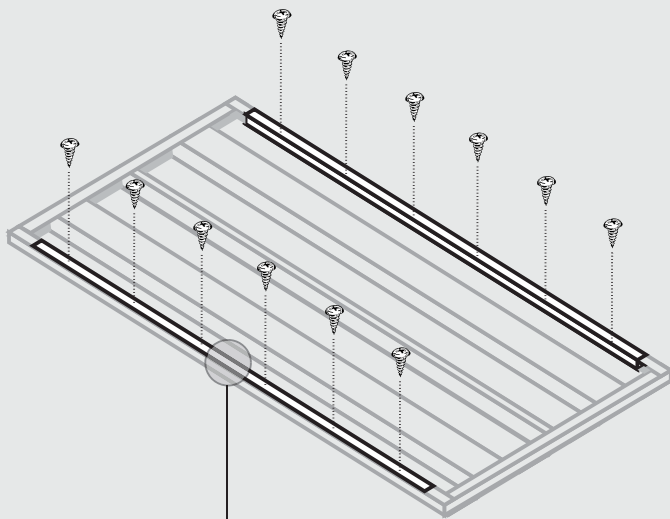

Fix each of the door boxing in place using six (6) screws.

Leave an even gap at both ends of the boxing J.

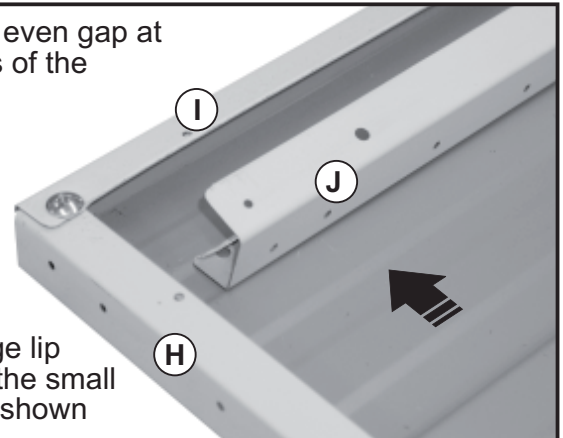

Place large lip of J over the small lip of I as shown

Use the pre punched holes in the door boxing as a guide to drill pilot holes in the door seal



Fix door seal on door number 2

## ASSEMBLE DOOR

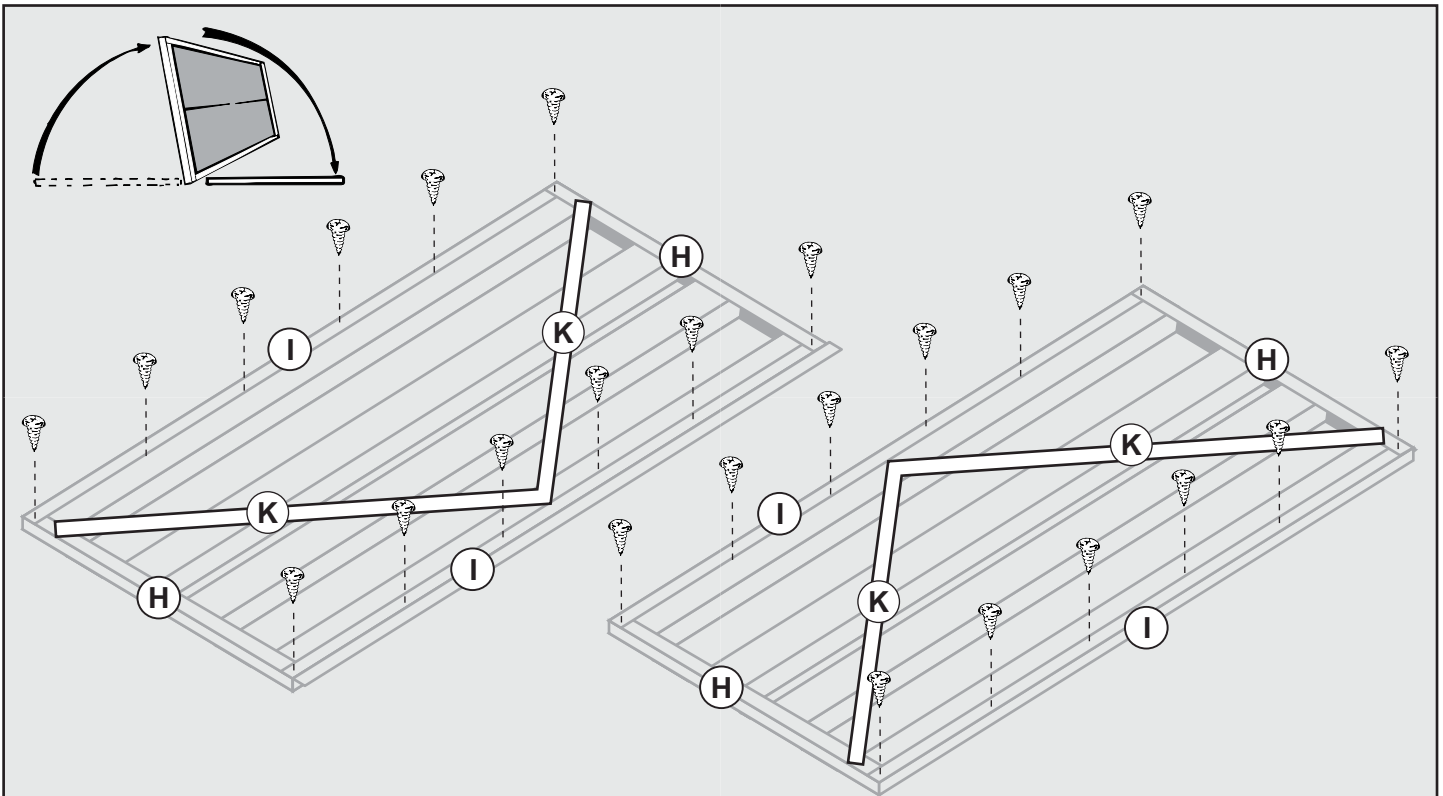

Flip the door assembly's over and fix the door frames with screws evenly spaced as shown above. Make sure to screw through the sheeting. Door bracing will also need to be fitted to the doors to ensure sturdiness.

4

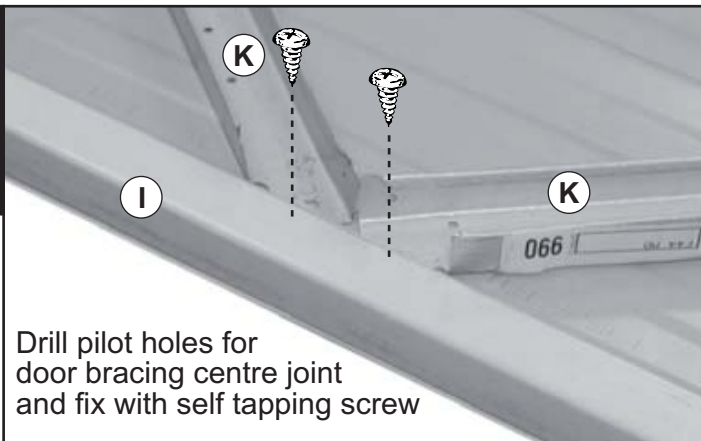

Drill pilot holes for door bracing centre joint and fix with self tapping screw

Drill pilot hole for top and bottom bracing joint, and fix with self tapping screw.

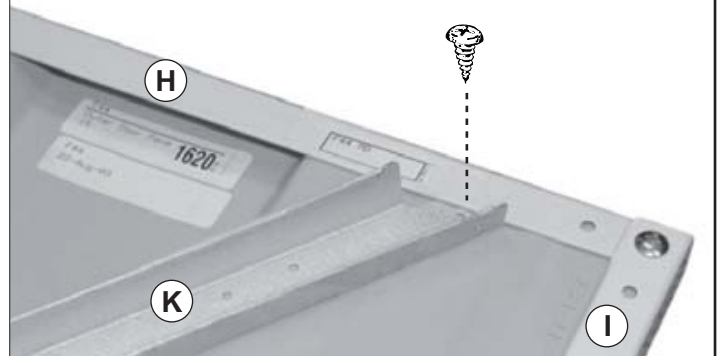

5

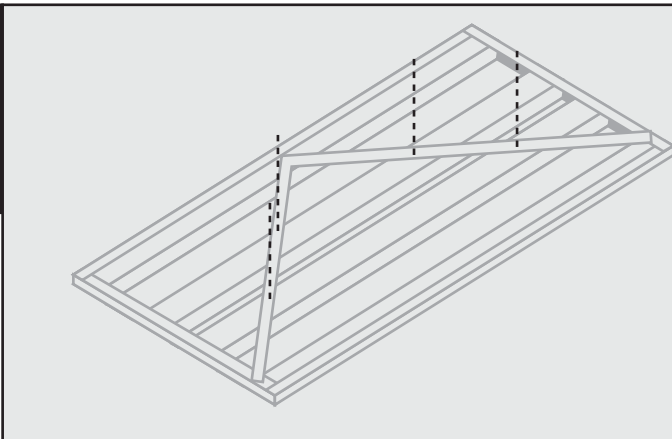

Now use the 2.5mm drill bit to drill pilot holes through the door bracing into the door sheeting.

**DO NOT SCREW BRACING AT THIS STAGE, SEE NEXT PAGE FOR DETAILS.**

# ASSEMBLE DOOR

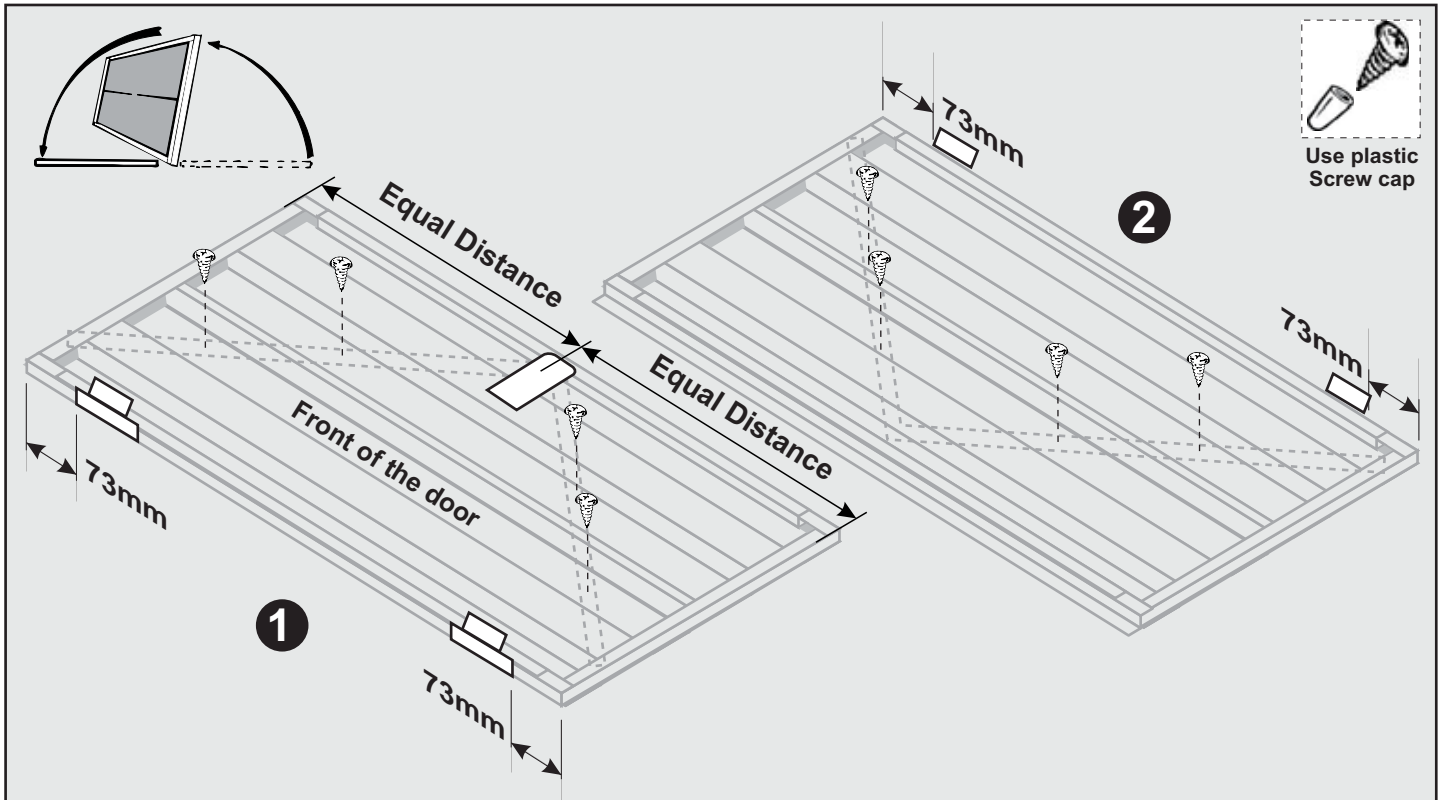

Flip the door back over to the front side facing up. Using the pilot holes drilled before, fix the door bracing from the front with self tapping screws. Use screw cap on all 8 screws here.

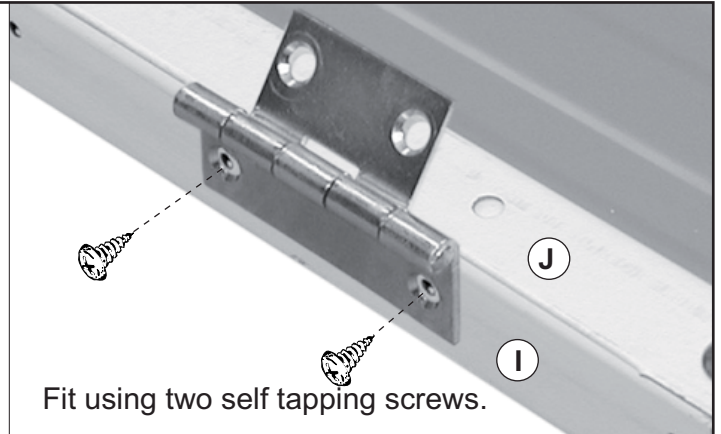
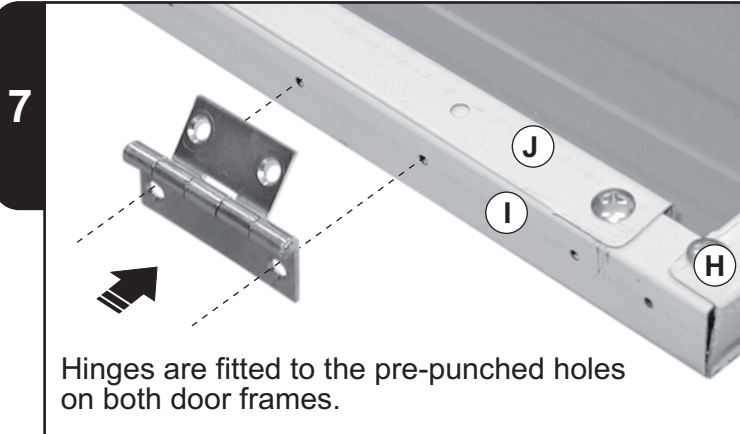
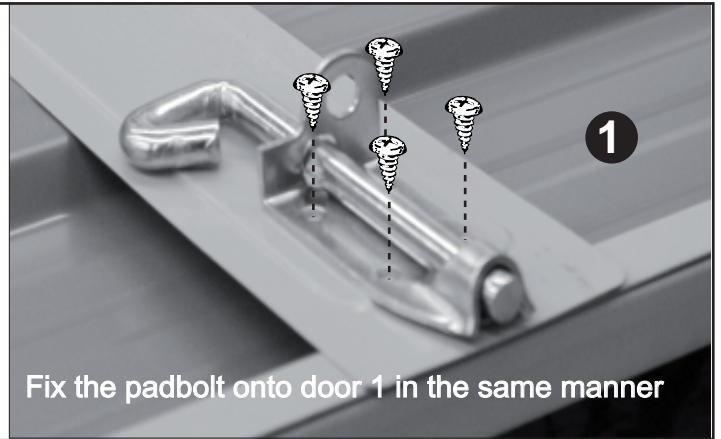
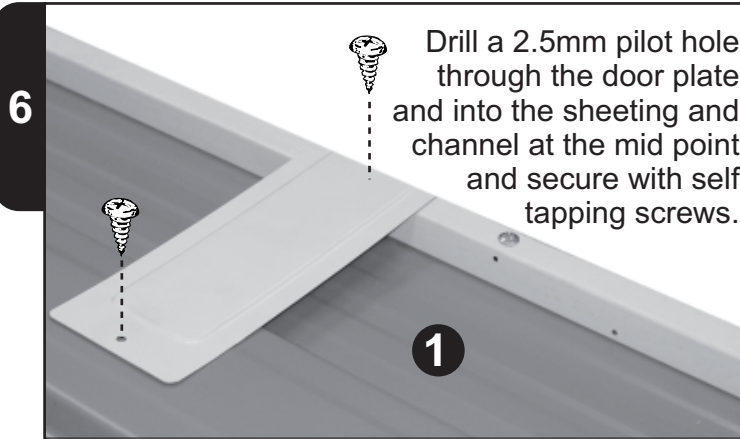

# BOLT DOWN

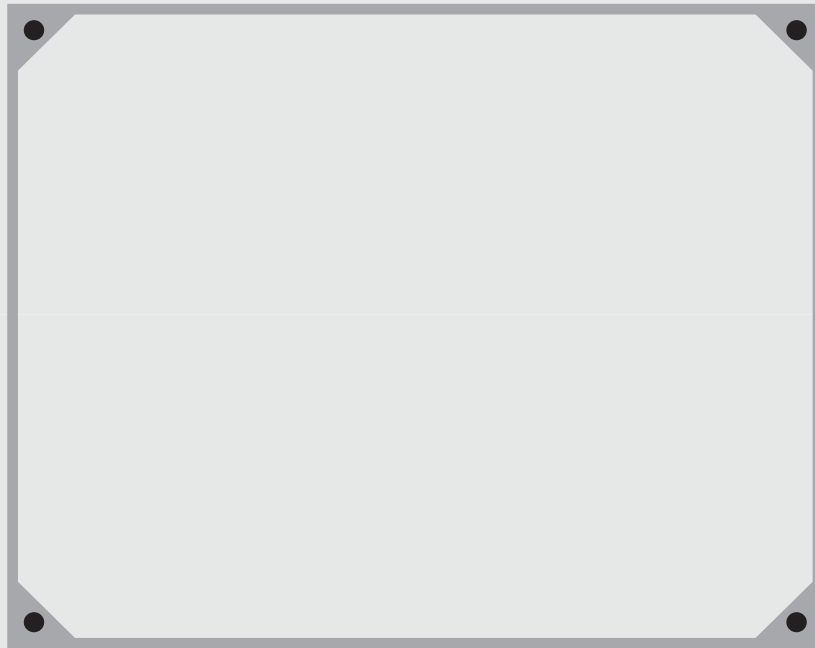

Bolt the shed down through the four corner brackets as shown. Ensure the shed is square.

1

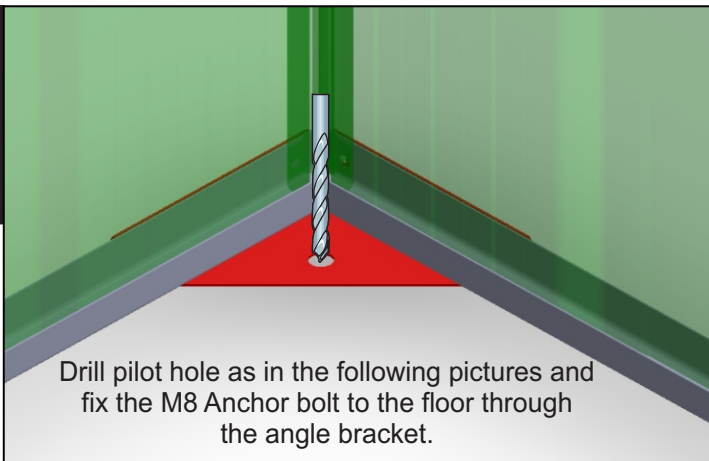

Drill pilot hole as in the following pictures and fix the M8 Anchor bolt to the floor through the angle bracket.

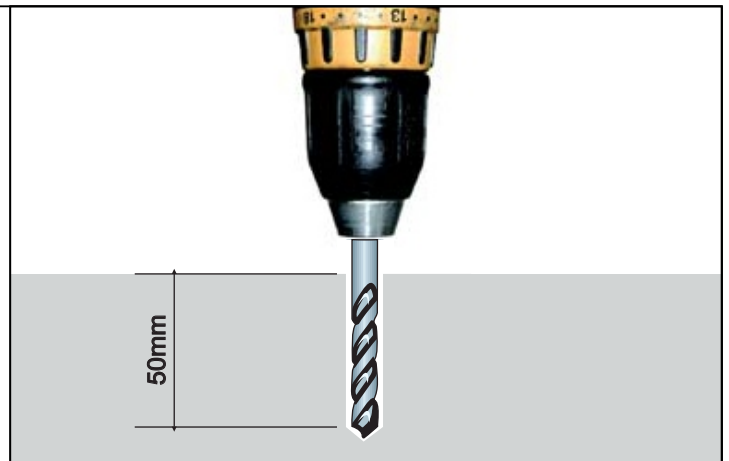

2

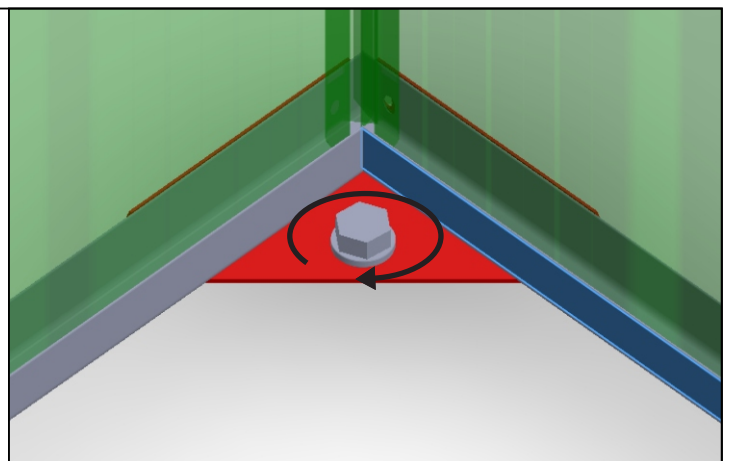
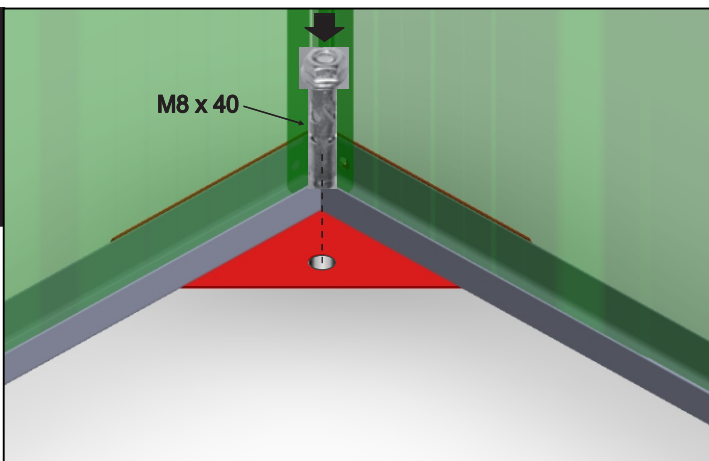

# BOLT DOWN

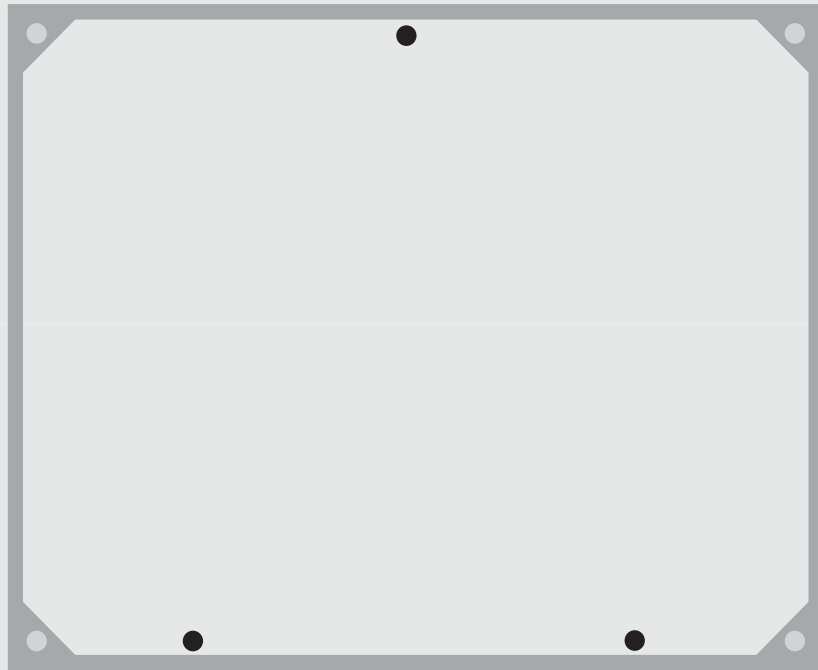

Bolt the shed down through the angle brackets as shown.

1

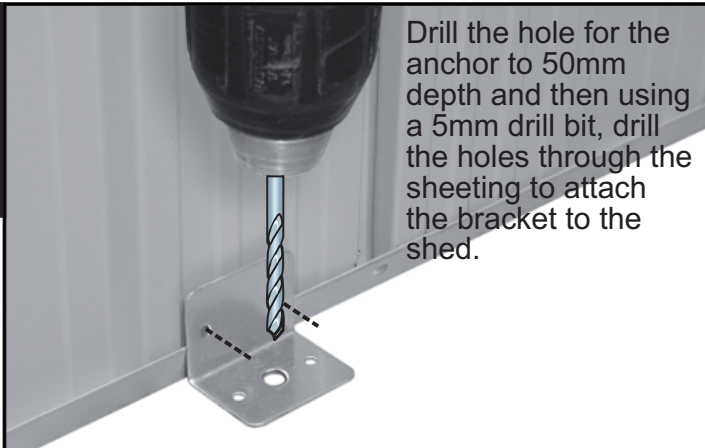

Drill the hole for the anchor to 50mm depth and then using a 5mm drill bit, drill the holes through the sheeting to attach the bracket to the shed.

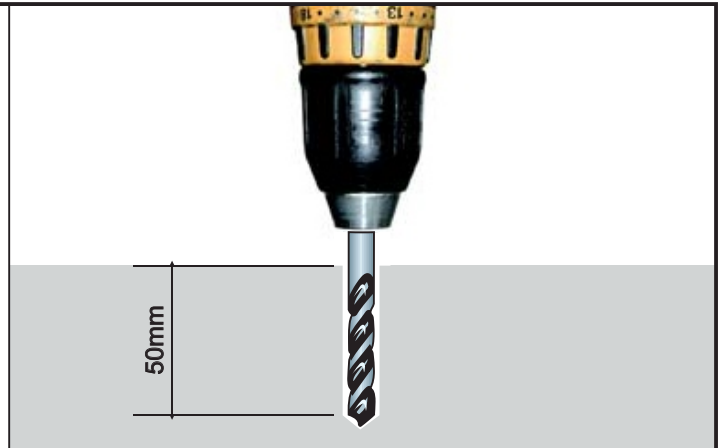

2

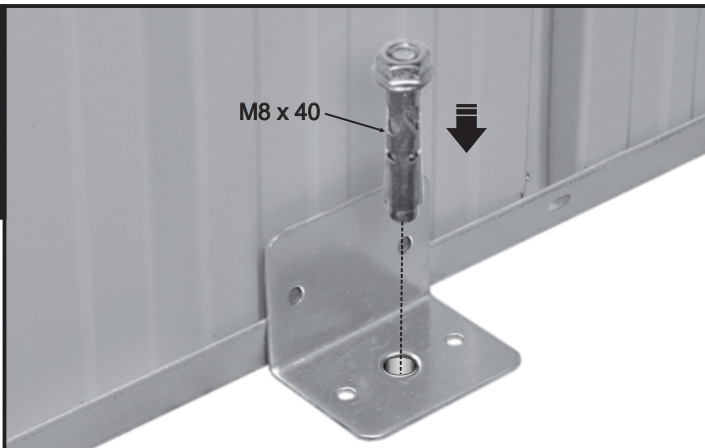

M8 x 40

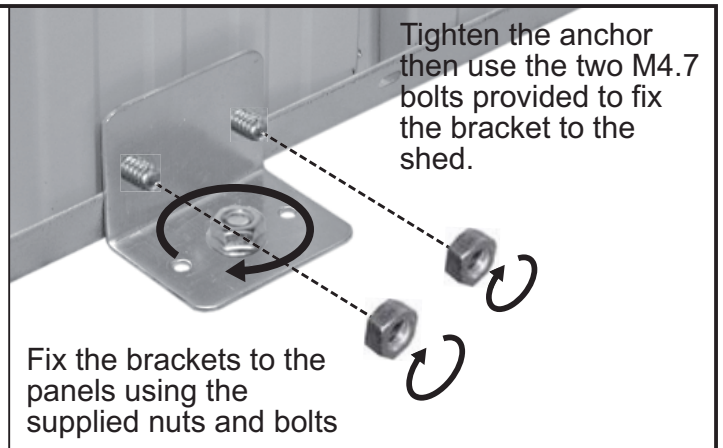

Tighten the anchor then use the two M4.7 bolts provided to fix the bracket to the shed.

Fix the brackets to the panels using the supplied nuts and bolts

# HANG DOOR

**NOTE:** The diagram below shows a 64 flat roof shed. The assembly process is the same for all sheds.

Fit the doors by fixing the hinges to the pre-drilled holes in the door jambs. Fit the padbolt and keeper to the front of the doors. To finish, fix padbolts to the inside, top and bottom of the door with the seal attached.

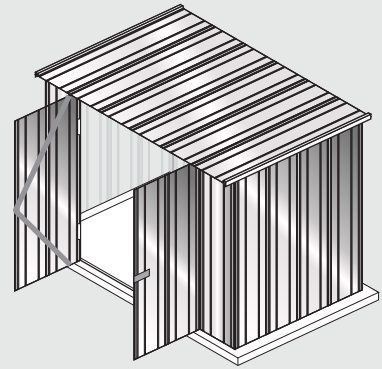

1



2



2

Drill pilot holes to accommodate the padbolt keeper and then fix with self tapping screws

3

Drill pilot holes into the inside of the door frame of the second door next to the door seal and then fix with self tapping screws.



2

Drill pilot holes into the inside of the front wall bottom channel to accommodate the padbolt keeper and then fix with self tapping screws

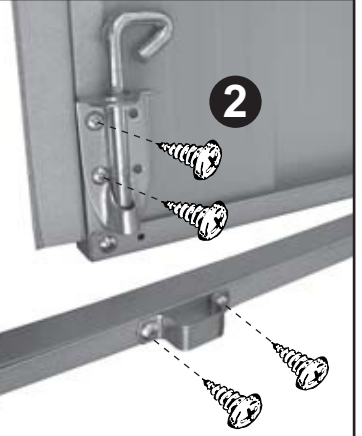

2



Simple, Strong,  
Quick & Easy

# 15 Years Warranty

## Thank you for purchasing FASTTRAK® system steel garden shed.®

Your personal warranty is backed by the manufacturer of FASTTRAK® system garden sheds, and our proven commitment to quality and customer service.

Our goods come with guarantees that cannot be excluded under Australian consumer law.

You are entitled to a replacement or refund of a major failure and compensation for any reasonably foreseeable loss or damage. You are also entitled to have the goods repaired or replaced if the goods fail to be of acceptable quality and the failure does not amount to a major failure. Cost of claiming the warranty will be by the claimant.

This warranty is in addition to other rights and remedies of the customer under law.

### Eligibility

- The 15 year warranty is eligible only to the original purchaser/owner of the shed as registered within 60 days from the date of purchase and is not transferable.
- The warranty is valid for Australia.
- The warranty is subject to location and local environmental conditions outlined in the warranty exclusions below.

### What is covered under the warranty?

FASTTRAK® steel garden shed 15 year warranty is limited to the following specific cover.

1. Zinc and/or galvanised panel materials will not rust
2. Coloured panel materials will not rust, flake, peel or blister.

Please note the 15 year warranty does not apply to any accessory items such as fasteners, Hasp, Pad bolts, also including flooring kits, shelving, hook sets, tool racks etc.

### Warranty Qualifications & Limitations

The FASTTRAK® 15 year warranty is subject to the following qualifications and limitations

1. Warranty does not apply to surface deterioration of the panels caused specifically by
  - a. "Swarf"(tiny particles of steel debris left from cutting, grinding or drilling operations) that have not been dutifully removed during the assembly construction process.
  - b. As a result of contact with damp soil, chemicals, fertilisers, or other corrosive substances
2. Warranty does not cover damage caused by storms, wind, rain, hail, snow or any other adverse environmental event or "act of god"
3. Warranty only applies if the shed is used solely for domestic purposes and installation is in accordance and compliance with the FASTTRAK® instruction manual and manufacturer recommendations.
4. Warranty does not apply if the shed is installed / located in
  - a. Ocean/surf locations (typically defined as within 1km from coastal or tidal locations),
  - b. Severe industrial locations
  - c. Unusually corrosive environments (e.g. Geothermal / Sulphuric conditions)
5. Warranty does not cover any damage as a result of
  - a. Any impact
  - b. Due to poor foundations
  - c. Modifications
  - d. Build-up of debris on or in roof or walls
  - e. Poor assembly and/or construction
6. The warranty will be void if the shed has been relocated from its original location / address
7. The warranty is limited to the replacement and delivery of panels and specifically excludes any labour, installation or removal/disposal costs.
8. Warranty applies to the exclusions of all other representations, guarantees or warranties, either expressed or implied unless otherwise required by applicable legislation.
9. Your warranty registration certificate and supporting documentation must be completed and lodged within 60 days of the date of purchase.

### Warranty Claims

All warranty claims should be made in writing sent directly to:

#### Australia

FASTTRAK  
PO Box 1581,  
Browns Plains, Queensland, 4118

### Claims must include:

- a) Original proof of purchase documentation
- b) Relevant contact information
- c) Product model
- d) Photographic evidence
- e) Description of the damage



**Simple, Strong,  
Quick & Easy.**

## Warranty Registration Certificate

### Owners Details

Owners Name:

Street Address:

City:

Postcode:

Email:

### Building Details

Product Model Number:

Colour:

Place of Purchase:

Purchase Date:

Please attach here a photocopy of proof of purchase

Retain the original for your records

You must submit your warranty registration certificate within 60 days of the purchase date of your FASTTRAK® garden shed.

Post your certificate and supporting documentation to:

### Australia

FASTTRAK

PO Box 1581, Browns Plains

Queensland, 4118

**FASTTRAK**

**Simple, Strong,  
Quick & Easy.**

